

# SIMPLICIAL COMPLEXES OF PLACEMENT GAMES

by

Svenja Huntemann

Submitted in partial fulfillment of the requirements  
for the degree of Master of Science

at

Dalhousie University  
Halifax, Nova Scotia  
August 2013

© Copyright by Svenja Huntemann, 2013

# Table of Contents

<b>List of Tables</b> . . . . .	<b>iv</b>
<b>List of Figures</b> . . . . .	<b>v</b>
<b>Abstract</b> . . . . .	<b>vii</b>
<b>List of Abbreviations and Symbols Used</b> . . . . .	<b>viii</b>
<b>Acknowledgements</b> . . . . .	<b>ix</b>
<b>Chapter 1 Introduction</b> . . . . .	<b>1</b>
1.1 Motivation . . . . .	1
1.2 Combinatorial Game Theory . . . . .	1
1.2.1 Boards . . . . .	4
1.2.2 Disjunctive Sum of Games . . . . .	4
1.2.3 $t$ -player Games . . . . .	6
1.3 Combinatorial Commutative Algebra . . . . .	7
1.4 Graph Theory . . . . .	10
<b>Chapter 2 Playing Games on Simplicial Complexes</b> . . . . .	<b>12</b>
2.1 The Game Polynomial . . . . .	12
2.2 Constructing Monomials and Simplicial Complexes from Placement Games . . . . .	13
2.3 The Ideals of a Placement Game . . . . .	16
2.4 Playing Games on Simplicial Complexes . . . . .	18
2.5 Questions . . . . .	20
<b>Chapter 3 Distance Games, the Bipartite Flip, and Doppelgänger</b> <b>22</b>	
3.1 Introduction . . . . .	22
3.2 The Bipartite Flip . . . . .	23
3.3 Doppelgänger . . . . .	28

<b>Chapter 4</b>	<b>Kruskal-Katona Type Bounds for Weight Games . . .</b>	<b>33</b>
4.1	The Kruskal-Katona Theorem . . . . .	33
4.2	Games with Weight . . . . .	34
4.3	Playing on the Path $P_n$ . . . . .	38
4.4	Playing on the Cycle $C_n$ . . . . .	43
4.5	Playing on the Complete Graph $K_n$ . . . . .	47
4.6	Playing on the Complete Bipartite Graph $K_{n,m}$ . . . . .	52
<b>Chapter 5</b>	<b>Conclusion: Open Questions and Discussion . . . . .</b>	<b>58</b>
5.1	Commutative Algebra of Placement Games . . . . .	58
5.2	Doppelgänger and Isomorphic Game Complexes . . . . .	58
5.3	On Distance Games and Games with Weight . . . . .	59
5.4	Overall . . . . .	60
<b>Bibliography</b>	. . . . .	<b>61</b>

## List of Tables

Table 3.1	Proof of Theorem 3.21: Number of Triples for Case 3c . . . . .	32
-----------	--	----

## List of Figures

Figure 1.1	A Traditional Board and Its Corresponding Graph . . . . .	5
Figure 1.2	A Legal Position in COL on $P_3$ . . . . .	5
Figure 1.3	A COL Position That is the Disjunctive Sum of Two COL Positions I . . . . .	5
Figure 1.4	A COL Position That is the Disjunctive Sum of Two COL Positions II . . . . .	6
Figure 1.5	An Example Position in 3-player COL . . . . .	6
Figure 1.6	An Example of a Simplicial Complex . . . . .	8
Figure 1.7	Facet Complex of $I = \langle x_1x_3, x_2x_3x_4 \rangle$ . . . . .	9
Figure 1.8	Stanley-Reisner Complex of $I = \langle x_1x_3, x_2x_3x_4 \rangle$ . . . . .	9
Figure 1.9	Examples of Graphs Considered . . . . .	10
Figure 2.1	Labeling $P_3$ . . . . .	14
Figure 2.2	Maximum Legal Positions for COL on $P_3$ . . . . .	14
Figure 2.3	The Game Complex $\Delta_{\text{COL}, P_3}$ . . . . .	14
Figure 2.4	The Game Complexes $\Delta_{\text{SNORT}, P_3}$ , $\Delta_{\text{SNORT}, C_3}$ , $\Delta_{\text{COL}, P_3}$ , and $\Delta_{\text{COL}, C_3}$ . . . . .	15
Figure 2.5	Labeling $C_3$ . . . . .	16
Figure 2.6	The Illegal Complex $\Gamma_{\text{COL}, P_3}$ . . . . .	18
Figure 2.7	The Illegal Complex $\Gamma_{\text{COL}, P_5}$ . . . . .	18
Figure 2.8	A Legal Position on $\Gamma_{\text{COL}, P_5}$ and on $P_5$ . . . . .	19
Figure 2.9	The Illegal Complex $\Gamma_{\text{NoGo}, P_3}$ . . . . .	19
Figure 2.10	A Legal and an Illegal Position when Playing on $\Delta_{\text{COL}, C_3}$ . . . . .	20
Figure 3.1	Positions of the Distance Game $G$ with $S_G = \{1\}$ and $D_G = \{2\}$ . . . . .	23
Figure 3.2	The Illegal Complex $\Gamma_{\text{SNORT}, P_5}$ . . . . .	28
Figure 3.3	Proof of Theorem 3.21: Boards for Case 3c . . . . .	30
Figure 4.1	An Example Board . . . . .	35

Figure 4.2	The Position $x_{1,2,3}y_{4,5,6}$ in $G$ and $x_1y_4$ in $H$ . . . . .	36
Figure 4.3	Proof to Proposition 4.10: Placing a Piece of Weight $a$ on a Path	39
Figure 4.4	An Example Position for $W(2, 3)$ on $P_5$ . . . . .	40
Figure 4.5	The Game Complex $\Delta_{W(2,3),P_5}$ . . . . .	41
Figure 4.6	An Example Position for $W(2, 3)$ on $C_5$ . . . . .	44
Figure 4.7	The Game Complex $\Delta_{W(2,3),C_5}$ . . . . .	45
Figure 4.8	An Example Position for $W(2, 2)$ on $K_4$ . . . . .	49
Figure 4.9	The Game Complex $\Delta_{W(2,2),K_4}$ . . . . .	49
Figure 4.10	An Example Position for $W'(3, 2)$ on $K_{2,2}$ . . . . .	55
Figure 4.11	The Game Complex $\Delta_{W(3,2),K_{2,2}}$ . . . . .	55

## Abstract

Placement games are a subclass of combinatorial games which are played on graphs. In this thesis, we demonstrate that placement games could be considered as games played on simplicial complexes. These complexes are constructed using square-free monomials.

We define new classes of placement games and the notion of Doppelgänger. To aid in exploring the simplicial complex of a game, we introduce the bipartite flip and develop tools to compare known bounds on simplicial complexes (such as the Kruskal-Katona bounds) with bounds on game complexes.

## List of Abbreviations and Symbols Used

Symbol	Page	Description
GAME	2	Text in small caps indicates a combinatorial game
$\mathcal{L}_{G,B}$	16	Legal ideal of the game $G$ played on the board $B$
$\mathcal{ILL}_{G,B}$	16	Illegal ideal of the game $G$ played on the board $B$
$\Delta_{G,B}$	14	Game complex of the game $G$ played on the board $B$
$\Gamma_{G,B}$	17	Illegal complex of the game $G$ played on the board $B$
$\mathcal{N}(\Delta)$	8	Stanley-Reisner ideal of the simplicial complex $\Delta$
$\mathcal{F}(\Delta)$	8	Facet ideal of the simplicial complex $\Delta$
$\mathcal{N}(I)$	8	Stanley-Reisner complex of the monomial ideal $I$
$\mathcal{F}(I)$	8	Facet complex of the monomial ideal $I$
$P_{G,B}(x)$	12	Game polynomial of the game $G$ played on the board $B$
$P_n$	10	Path of length $n$
$C_n$	10	Cycle of length $n$
$K_n$	10	Complete graph on $n$ vertices
$K_{n,m}$	10	Complete bipartite graph on $n$ and $m$ vertices
$BF_{V_2}$	25	The bipartite flip
$\mathcal{A}$	23	Distance games with $L_G = R_G$ played on bipartite boards
$\mathcal{B}$	4	A set of boards
$W(a, b)$	35	Weight game where Left plays weight $a$ and Right weight $b$



## Acknowledgements

First, and foremost, I want to express my gratitude to Sara Faridi and Richard Nowakowski. I could not have wished for better supervisors. Your guidance, patience, and encouragements are truly appreciated.

Further, I would like to thank my readers Jason Brown and Peter Selinger for their time and suggestions.

Finally, I wish to thank my family, especially my wonderful parents, who have been supporting me in all my endeavours.

# Chapter 1

## Introduction

### 1.1 Motivation

Combinatorial games are those games that involve pure strategies, for example chess or checkers. Recently, counting the number of allowed positions with a fixed number of pieces for combinatorial games in which pieces are placed on a board (like GO or TIC-TAC-TOE) has received attention (see for example [10], [19], [9] and [6]). One of the reasons why this problem is interesting to a game theorist is that the results are independent of whether we are playing a normal game (in which the first player unable to move loses) or *misère* (in which the first player unable to move wins), and *misère* games are often much harder to solve than normal-play games.

In this work, we will introduce a construction that associates a placement game with a set of square-free monomials and a simplicial complex. We hope to be able to use this connection between combinatorial game theory and combinatorial commutative algebra to apply results from one area to the other.

### 1.2 Combinatorial Game Theory

Before the 20th century, game theory consisted of studying one game at a time. This changed in the 1930s when Sprague [17] and Grundy [12] pointed out that Bouton's [5] work from 1902 on NIM (a game with heaps of coins in which players take turns picking a heap and removing coins from it) is applicable to a large class of combinatorial games.

Combinatorial game theory was greatly advanced by the publication of *On Numbers and Games* by Conway [7] in 1976 and *Winning Ways* by Berlekamp, Conway, and Guy [2] in 1982 in which many of the concepts that now build the foundations of the area were introduced. To honour Conway's contributions, combinatorial games as we define them in this thesis are also sometimes called Conway games.

In the last 30 years, game theory has evolved and grown steadily. Today, combinatorial game theory is of interest to both mathematicians and computer scientists. *Lessons in Play* [1] gives a good introduction to the fundamental theories, but all concepts that we need will be introduced in the thesis.

For a game, **perfect information** means that both players know which game they are playing, on which board, and the current position. No **chance** means that no dice can be rolled or cards can be dealt, or any other item involving probability can be used.

**Definition 1.1.** A **combinatorial game** is a 2-player game with perfect information and no chance, where the two players are **Left** and **Right** (denoted by  $L$  and  $R$  respectively) and they do not move simultaneously. Then a game is a set  $P$  of **positions**. **Rules** determine from which position to which position the players can move. A **legal position** is a position that can be reached by playing the game according to the rules.

In this thesis, a combinatorial game will be denoted by its name in SMALL CAPS. Well known examples of combinatorial games are CHESS, CHECKERS, TIC-TAC-TOE, GO, and CONNECT FOUR. Examples of games that are not combinatorial games include bridge, backgammon, poker, and Snakes and Ladders.

Although games usually have a ‘winning condition’ associated to them, i.e. rules as to which player wins, for the purposes of this thesis games do not necessarily need to have a notion of winning identified.

For the remainder, we will assume that the board on which games are played is a graph (or can be represented as a graph, see Section 1.2.1). A space on a board is then equivalent to a vertex and we use the two terms interchangeably. We will also assume that any rule for a game is **universal**, i.e. that it holds for every space of the board, and we will call this condition **universality**. For example, the game played on a strip in which a player may not place a piece beside one of their opponent’s, except if either is piece is at the end, does not satisfy universality since the rules for the spaces at the end are different then the rules for all other spaces.

**Definition 1.2** (Brown et al. [6]). A **placement game** is a combinatorial game which satisfies the following:

- (i) The board is empty at the beginning of the game.
- (ii) Players place pieces on empty spaces of the board according to the rules.
- (iii) Pieces are not moved or removed once placed.
- (iv) The rules are such that if it is legal to place a piece in a space, then it must have been legal at any other point before.

The TRIVIAL placement game on a board is the placement game that has no additional rules.

In this work, we will be considering placement games exclusively, a class of games only recently defined formally by Brown et al. in [6], even though several placement games, for example TIC-TAC-TOE, have been known and studied for a long time.

The following three games are good examples for placement games. The first two are well known in combinatorial game theory (see for example [3]).

**Definition 1.3.** In SNORT, players may not place pieces on a vertex adjacent to a vertex containing a piece from their opponent.

**Definition 1.4.** In COL, players may not place pieces on a vertex adjacent to a vertex containing one of their own pieces.

**Definition 1.5.** In NOGO, at every point in the game, for each maximal group of connected vertices of the board that contain pieces placed by the same player, one of these needs to be adjacent to an empty vertex.

**Example 1.6.** Examples of legal alternating sequences of play for each are the following:

SNORT:

$$\boxed{\phantom{L}}\boxed{\phantom{L}}\boxed{\phantom{L}} \xrightarrow{L} \boxed{L}\boxed{\phantom{L}}\boxed{\phantom{L}} \xrightarrow{R} \boxed{L}\boxed{\phantom{L}}\boxed{R}$$

COL:

$$\boxed{\phantom{L}}\boxed{\phantom{L}}\boxed{\phantom{L}} \xrightarrow{L} \boxed{L}\boxed{\phantom{L}}\boxed{\phantom{L}} \xrightarrow{R} \boxed{L}\boxed{R}\boxed{\phantom{L}} \xrightarrow{L} \boxed{L}\boxed{R}\boxed{L}$$

NOGO:

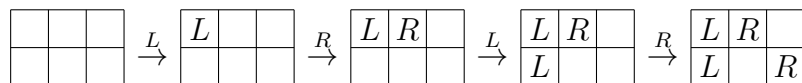

Note that other sequences of play are possible for each of these games, and we do not claim that the sequence given are optimal under any circumstances.

Even though COL and SNORT seem like very similar games from their definitions, they differ greatly (placing pieces in SNORT ‘reserves’ spaces for oneself, while in COL one reserves spaces for the opponent), and strategies for winning one are bad for the other. Surprisingly, as we will show in Section 3.2, COL and SNORT are on the other hand closely related when played on certain boards, as we can construct one from the other. This shows that although they have been known for a long time, they are not yet completely understood.

The game NOGO is very different from COL and SNORT, and thus provides another good example to consider.

In all three of these games, the pieces only occupy one vertex each, which is not necessary though. For example in CROSSCRAM [11] and DOMINEERING [3] the players’ pieces occupy two adjacent vertices.

### 1.2.1 Boards

To reiterate, when we use the word “board”, we mean a graph on whose vertices the pieces are placed. A more ‘traditional’ board, for example a checkerboard, can be represented by a graph by assigning to each space a vertex and connecting two vertices if and only if the two corresponding spaces are horizontally or vertically adjacent. For example the board on the left in Figure 1.1 is represented by the graph on the right.

We do not consider graphs of only this type for boards though, but *any* graph, for example the cycle  $C_5$  or the graph given in Figure 4.1. Sometimes, we consider a game played on several different boards. In this case, we will denote the set of boards by  $\mathcal{B}$ .

### 1.2.2 Disjunctive Sum of Games

**Definition 1.7.** The **disjunctive sum** between two positions of combinatorial games  $G$  and  $H$  is the position in which a player can play in one of  $G$  and  $H$  but not both simultaneously.

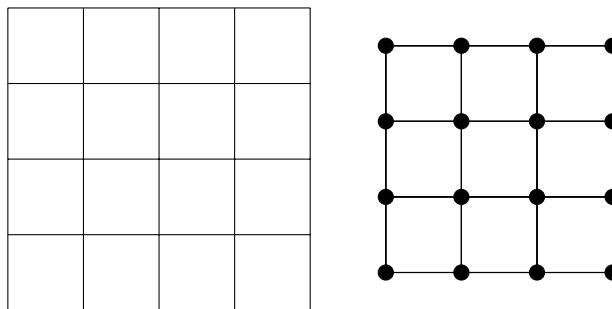

Figure 1.1: A Traditional Board and Its Corresponding Graph

For a combinatorial game, the condition that players may not move simultaneously (see Definition 1.1) is usually replaced with the stronger condition of players taking alternating turns. Since we assume that games are part of a disjunctive sum though, players can effectively ‘skip’ their turn on a board by playing on the other board, i.e. not moving simultaneously and taking alternating turns are equivalent for the purpose of this thesis.

Assuming implicitly that placement games are part of a disjunctive sum implies that a board might be filled with more pieces of one player than of the other. For example, for COL played on the path  $P_3$  the position in Figure 1.2 is legal.



Figure 1.2: A Legal Position in COL on  $P_3$

Making this assumption is very useful since in many placement games the board might ‘break up’ into the disjunctive sum of smaller boards.

**Example 1.8.** For another example, consider COL played on the path  $P_7$ . If Right has played in the third and fifth space, and Left in the fourth space, then this position is equivalent to the one in which the middle space is ‘deleted’ (see Figure 1.3).



Figure 1.3: A COL Position That is the Disjunctive Sum of Two COL Positions I

Now if the game continues, we might have a position as on the left in Figure 1.4, which would be equivalent to the disjunctive sum of the two COL positions on the right, one of which has two Right pieces but no Left pieces.

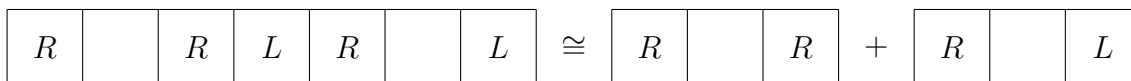

Figure 1.4: A COL Position That is the Disjunctive Sum of Two COL Positions II

The argument of a board breaking up into smaller board as play progresses is indirectly used in the proof of Proposition 4.10, where playing a second piece on a strip is equivalent to placing one piece on a smaller strip, an easier problem that was solved earlier.

### 1.2.3 $t$ -player Games

Even though we normally only consider 2-player games in combinatorial game theory, we can generalize many games to other numbers of players. We call such games  $t$ -player games. Since we are assuming that all games can be part of a disjunctive, the order in which the players take their turns does not matter.

**Example 1.9.** We can generalize COL to a  $t$ -player version by using the same rules as in Definition 1.4. For example, for a 3-player version of COL on the path  $P_5$ , we introduce a third player called Middle, whose pieces are denoted by  $M$ . Figure 1.5 gives an example position for such a game.



Figure 1.5: An Example Position in 3-player COL

In Chapter 4, we look at  $t$ -player games. We find this useful because some 2-player games turn out to be equivalent to simpler  $t$ -player games.

### 1.3 Combinatorial Commutative Algebra

Combinatorial commutative algebra is an area in which combinatorial concepts are used to study objects in commutative algebra and vice versa. One of the main roots of combinatorial algebra lies in the relationship between square-free monomial ideals and simplicial complexes. This connection was first studied by Stanley in 1975 [18], by Reisner in 1976 [16], and by Hochster in 1977 [13] via the concept of the Stanley-Reisner ideal of a simplicial complex.

Edge ideals for graphs were then introduced by Villarreal in 1990 [20], and these were generalized to facet ideals for simplicial complexes by Faridi in 2002 [8].

**Definition 1.10.** A **simplicial complex**  $\Delta$  on a finite vertex set  $V$  is a set of subsets (called **faces**) of  $V$  with the conditions that if  $A \in \Delta$  and  $B \subseteq A$ , then  $B \in \Delta$ . The **facets** of a simplicial complex  $\Delta$  are the maximal faces of  $\Delta$  with respect to inclusion. A **non-face** of a simplicial complex  $\Delta$  is a subset of its vertices that is not a face. The  **$f$ -vector**  $(f_0, f_1, \dots, f_k)$  of a simplicial complex  $\Delta$  enumerates the number of faces  $f_i$  with  $i$  vertices. Note that if  $\Delta \neq \emptyset$ , then  $f_0 = 1$ .

In the algebraic literature, the  $f$ -vector of a complex is usually indexed from  $-1$  to  $k - 1$  as this is the “dimension” of the face (the number of vertices minus 1). Due to the connection between placement games and simplicial complexes (see Section 2.2), we have chosen the combinatorial indexing.

**Definition 1.11.** An **ideal**  $I$  of a ring  $R = R(+, \cdot)$  is a subset of  $R$  such that  $(I, +)$  is a subgroup of  $R$  and  $rI \subseteq I$  for all  $r \in R$ .

In a polynomial ring  $R$ , since  $R$  is Noetherian by the Hilbert basis theorem, every ideal  $I$  has a finite number of **generators**, i.e. there exist  $g_1, \dots, g_q \in R$  such that  $I = \{\sum_{i=1}^q r_i g_i \mid r_i \in R, i = 1, \dots, q\}$ . We then say that  $I$  is generated by  $g_1, \dots, g_q$ .

**Definition 1.12.** Let  $k$  be a field and  $R$  the polynomial ring  $k[x_1, \dots, x_n]$ . A product  $x_1^{a_1} \dots x_n^{a_n} \in R$ , where the  $a_i$  are non-negative integers, is called a **monomial**. Such a monomial is called **square-free** if each  $a_i$  is either 0 or 1. The sum  $a_1 + \dots + a_n$  is called the **degree** of the monomial  $x_1^{a_1} \dots x_n^{a_n}$ .



**Definition 1.13.** Let  $k$  be a field and  $R$  the polynomial ring  $k[x_1, \dots, x_n]$ . A **monomial ideal** of  $R$  is an ideal generated by monomials in  $R$ . A monomial ideal is called a **square-free monomial ideal** if the monomials generating it are square-free.

Let  $k$  be a field and  $R = k[x_1, \dots, x_n]$  a polynomial ring. Given a simplicial complex  $\Delta$  on  $n$  vertices, we can label each vertex with an integer from 1 to  $n$ . Each face  $F$  (resp. non-face  $N$ ) of  $\Delta$  can then be represented by a square-free monomial of  $R$  by including  $x_i$  in the monomial representing the face  $F$  (resp. the non-face  $N$ ) if and only if the vertex  $i$  belongs to  $F$  (resp.  $N$ ). We then have the following:

**Definition 1.14.** The **facet ideal** of a simplicial complex  $\Delta$ , denoted by  $\mathcal{F}(\Delta)$ , is the ideal generated by the monomials representing the facets of  $\Delta$ . The **Stanley-Reisner ideal** of a simplicial complex  $\Delta$ , denoted by  $\mathcal{N}(\Delta)$ , is the ideal generated by the monomials representing the minimal non-faces of  $\Delta$ .

**Definition 1.15.** The **facet complex** of a square-free monomial ideal  $I$ , denoted by  $\mathcal{F}(I)$ , is the simplicial complex whose facets are represented by the square-free monomials generating  $I$ . The **Stanley-Reisner complex** of a square-free monomial ideal  $I$ , denoted by  $\mathcal{N}(I)$ , is the simplicial complex whose faces are represented by the square-free monomials not in  $I$ .

To clarify these concepts, we will give two examples:

**Example 1.16.** Consider the simplicial complex  $\Delta$  in Figure 1.6 with the labeling of the vertices as given.

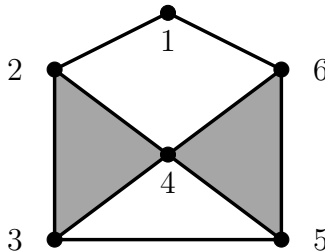

Figure 1.6: An Example of a Simplicial Complex

The facet ideal of  $\Delta$  then is

$$\mathcal{F}(\Delta) = \langle x_1x_2, x_1x_6, x_2x_3x_4, x_3x_5, x_4x_5x_6 \rangle,$$

and the Stanley-Reisner ideal of  $\Delta$  is

$$\mathcal{N}(\Delta) = \langle x_1x_3, x_1x_4, x_1x_5, x_2x_5, x_2x_6, x_3x_4x_5, x_3x_6 \rangle.$$

**Example 1.17.** Consider the square-free monomial ideal  $I = \langle x_1x_3, x_2x_3x_4 \rangle$ . The facet complex  $\mathcal{F}(I)$  is given in Figure 1.7 and the Stanley-Reisner complex  $\mathcal{N}(I)$  is given in Figure 1.8.

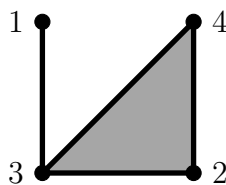

Figure 1.7: Facet Complex of  $I = \langle x_1x_3, x_2x_3x_4 \rangle$

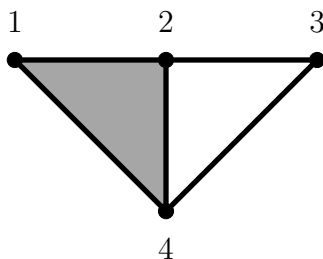

Figure 1.8: Stanley-Reisner Complex of  $I = \langle x_1x_3, x_2x_3x_4 \rangle$

It is clear that the facet operators are inverses of each other, i.e.  $\mathcal{F}(\mathcal{F}(\Delta)) = \Delta$  and  $\mathcal{F}(\mathcal{F}(I)) = I$ , from their definitions. This is also true of the Stanley-Reisner operators: A minimal non-face of  $\mathcal{N}(I)$  is a minimal monomial generator of  $I$ , thus a generator of  $I$ , showing  $\mathcal{N}(\mathcal{N}(I)) = I$ . Similarly, since  $\mathcal{N}(\Delta)$  contains all monomials representing non-faces, a square-free monomial not in  $\mathcal{N}(\Delta)$  has to be a face of  $\Delta$ , thus  $\mathcal{N}(\mathcal{N}(\Delta)) = \Delta$ .

This shows that both the facet and the Stanley-Reisner operators give a bijection between the set of all square-free monomial ideals in  $n$  variables and the set of all simplicial complexes on  $n$  vertices.

## 1.4 Graph Theory

Since we are playing games on graphs, we will need a few definitions from graph theory. See for example [4].

**Definition 1.18.** A **simple graph** is a graph with no loops (an edge that has identical ends) and no parallel edges (two or more edges that share the same two ends). The **degree** of a vertex in a simple graph is the number of edges incident with it.

**Definition 1.19.** A **path**  $P_n$  is a connected simple graph on  $n \geq 2$  vertices such that two vertices have degree 1 and  $n - 2$  vertices have degree 2.

**Definition 1.20.** A **cycle**  $C_n$  is a connected simple graph on  $n \geq 3$  vertices such that all vertices have degree 2.

**Definition 1.21.** A **complete graph**  $K_n$  is a simple graph on  $n$  vertices such that any two vertices are adjacent.

**Definition 1.22.** A **bipartite graph**  $G$  is a simple graph whose vertices can be partitioned into two sets  $V_1$  and  $V_2$  such that every edge of  $G$  has one vertex in  $V_1$  and the other in  $V_2$ . The sets  $V_1$  and  $V_2$  are the **parts** of  $G$ .

**Definition 1.23.** A **complete bipartite graph**  $K_{n,m}$  is a bipartite graph whose parts  $V_1$  and  $V_2$  have size  $n$  and  $m$  respectively, and such that every vertex in  $V_1$  is connected with every vertex in  $V_2$ .

**Example 1.24.** For an example of each graph, see Figure 1.9.

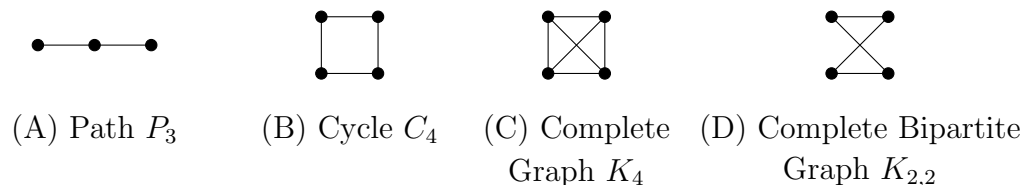

Figure 1.9: Examples of Graphs Considered

**Definition 1.25.** A **path between two vertices  $v$  and  $w$**  in a graph  $G$  is a sequence of vertices  $v = v_1, v_2, \dots, v_k = w$  of  $G$  such that  $v_i$  and  $v_{i+1}$  are connected by an edge and no edge is repeated. The **distance** between two vertices  $v$  and  $w$  is the number of edges of the shortest path between  $v$  and  $w$ , i.e. the number of vertices in the shortest path minus 1. The **diameter** of a graph  $G$ , denoted  $diam(G)$ , is the largest distance between any pair of vertices in  $G$ .

## Chapter 2

### Playing Games on Simplicial Complexes

We will start this chapter by giving an introduction to game polynomials, a new concept in combinatorial game theory developed by Brown et al. in [6], which will be studied throughout this work.

We then show that to each placement game we can associate a set of square-free monomials representing the legal positions of the game. From this set of monomials, we can then build a simplicial complex, which we call the game complex. To illustrate this useful construction, we will construct the game complexes of COL and SNORT on two different boards.

Next, we define the legal and illegal ideal of a placement game, and introduce the illegal complex, which is closely related to the game complex. Finally, we will demonstrate that a placement game can also be played on its game complex and illegal complex.

#### 2.1 The Game Polynomial

For a placement game  $G$  and a board  $B$ , let

$$f_i(G, B)$$

denote the number of positions with  $i$  pieces played, regardless of which player the pieces belong to. If the game and board are clear from context, we shorten the notation to  $f_i$ .

**Definition 2.1** (Brown et al. [6]). For a game  $G$  played on a board  $B$ , the **game polynomial** is defined to be

$$P_{G,B}(x) = \sum_{i=0}^k f_i(G, B)x^i.$$

$P_{G,B}(1)$  is then the total number of legal positions of the game.

The motivation for game polynomials came from work of Farr [10] in 2003 where the number of end positions and some polynomials of the game GO were considered, and work in this area was continued by Tromp and Farneback [19] in 2007 and by Farr and Schmidt [9] in 2008. Even though GO is not a placement game since pieces are removed, it shares many properties with this class of games. Thus it was natural for the authors of [6] to consider the concept of game polynomials for placement games.

**Example 2.2.** Consider COL played on the path  $P_3$ . The legal positions are

$$\begin{aligned} & \dots \quad L \cdot \cdot \quad \cdot L \cdot \quad \cdot \cdot L \quad R \cdot \cdot \quad \cdot R \cdot \quad \cdot \cdot R \\ & L \cdot L \quad R \cdot R \quad LR \cdot \quad L \cdot R \quad RL \cdot \quad R \cdot L \quad \cdot LR \quad \cdot RL \\ & LRL \quad RLR. \end{aligned}$$

so that

$$f_0 = 1 \quad f_1 = 6 \quad f_2 = 8 \quad f_3 = 2$$

and the game polynomial is

$$P_{\text{COL}, P_3}(x) = 1 + 6x + 8x^2 + 2x^3$$

giving the total number of legal positions being  $P_{\text{COL}, P_3}(1) = 17$ .

## 2.2 Constructing Monomials and Simplicial Complexes from Placement Games

We will now introduce a construction that associates a set of monomials and a simplicial complex to each placement game.

Given a placement game  $G$  on a board  $B$ , we can construct a set of square-free monomials in the following way: First, assign a label to each space on  $B$ . For each legal position we then create a square-free monomial by including  $x_i$  if Left has played in position  $i$  and  $y_i$  if Right has placed in position  $i$ . The empty position (before anyone has started playing) is represented by 1.

**Example 2.3.** Consider COL played on the path  $P_3$ . We label the spaces of the board as given in Figure 2.1.

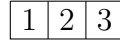

Figure 2.1: Labeling  $P_3$

The monomials representing legal positions (see Example 2.2) are then

$$\{1, x_1, x_2, x_3, y_1, y_2, y_3, x_1x_3, y_1y_3, x_1y_2, x_1y_3, y_1x_2, y_1x_3, x_2y_3, y_2x_3, x_1y_2x_3, y_1x_2y_3\}$$

The maximum legal positions and their corresponding monomials are given in Figure 2.2.

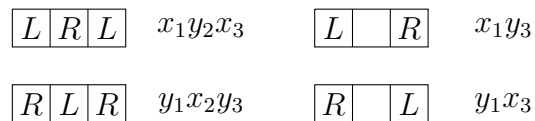

Figure 2.2: Maximum Legal Positions for COL on  $P_3$

Using these monomials, we can build a simplicial complex  $\Delta_{G,B}$  on the vertex set  $V = \{x_1, \dots, x_n, y_1, \dots, y_o\}$  by letting a subset  $F$  of  $V$  be a face if and only if there exists a square-free monomial  $m$  representing a legal position such that each element of  $F$  divides  $m$ .

**Definition 2.4.** A simplicial complex that can be constructed from a placement game  $G$  on a board  $B$  in this way is called a **game complex** and is denoted by  $\Delta_{G,B}$ .

**Example 2.5.** Consider COL played on the path  $P_3$ . Using the notation from Examples 2.2 and 2.3, we get the game complex  $\Delta_{\text{COL},P_3}$  as given in Figure 2.3.

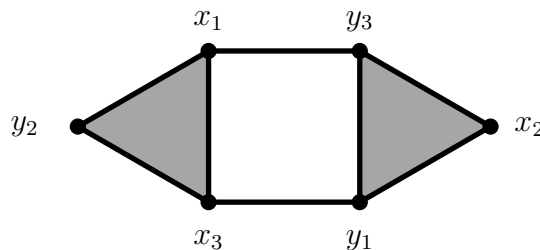

Figure 2.3: The Game Complex  $\Delta_{\text{COL},P_3}$

Observe that the maximum legal positions of a game, i.e. the positions in which no piece can be placed by either Left or Right (so the game ends), correspond to the facets of  $\Delta_{G,B}$  and thus uniquely determine  $\Delta_{G,B}$ .

In game theoretic terms, the  $f$ -vector of a game complex  $\Delta_{G,B}$  indicates that there are  $f_i$  legal positions with  $i$  pieces in the game  $G$ , regardless if pieces belong to Left or to Right. Thus for placement games the entries of the  $f$ -vector of the game complex  $\Delta_{G,B}$  are the coefficients of the game polynomial  $P_{G,B}$ . Therefore we have the following equalities:

$$\begin{aligned} f_i(G, B) &= \text{number of legal positions in } G \text{ with } i \text{ pieces played on } B, \\ &= \text{number of degree } i \text{ monomials representing legal positions in } G, \\ &= \text{number of faces with } i \text{ vertices in } \Delta_{G,B}, \end{aligned}$$

and we can use any of these concepts to find  $f_i$ .

We now give three more examples for the construction of monomials and simplicial complexes.

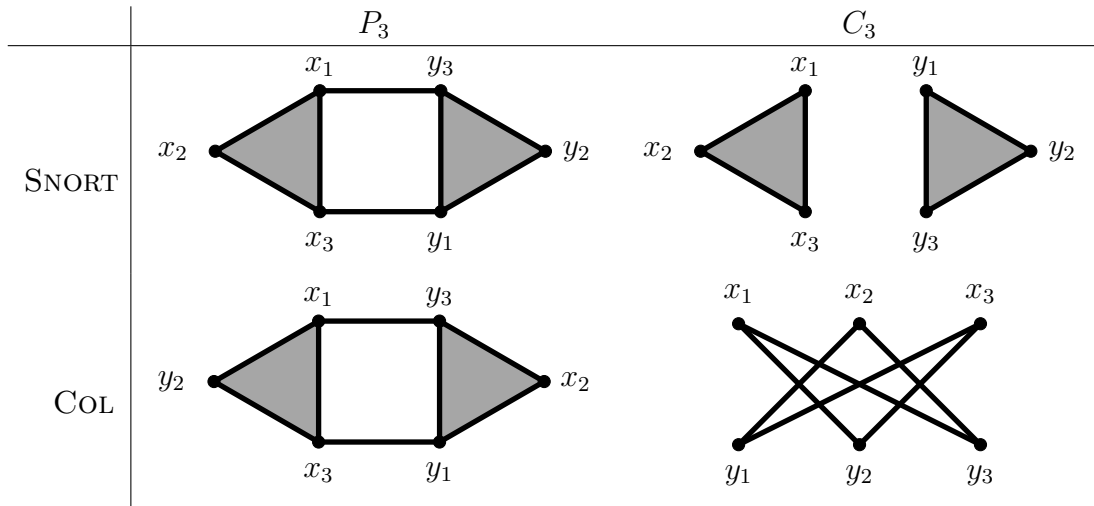

Figure 2.4: The Game Complexes  $\Delta_{\text{SNORT},P_3}$ ,  $\Delta_{\text{SNORT},C_3}$ ,  $\Delta_{\text{COL},P_3}$ , and  $\Delta_{\text{COL},C_3}$

**Example 2.6.** Consider COL played on the cycle  $C_3$ . The labels for different positions are given in Figure 2.5.

The monomials corresponding to the maximum legal positions are

$$\{x_1y_2, x_1y_3, x_2y_3, y_1x_2, y_1x_3, y_2x_3\}$$

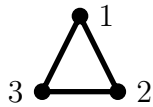

Figure 2.5: Labeling  $C_3$ 

and the game complex  $\Delta_{\text{COL},C_3}$  is given in Figure 2.4.

**Example 2.7.** Consider SNORT played on  $P_3$ . We label the path the same way as in Example 2.2. The maximum monomials then are

$$\{x_1x_2x_3, y_1y_2y_3, x_1y_3, x_3y_1\}$$

and the game complex  $\Delta_{\text{SNORT},P_3}$  is given in Figure 2.4.

**Example 2.8.** Consider SNORT played on  $C_3$ . We label the path the same way as in Example 2.6. The maximum monomials then are

$$\{x_1x_2x_3, y_1y_2y_3\}$$

and the game complex  $\Delta_{\text{SNORT},C_3}$  is given in Figure 2.4.

Note that the game complexes for COL and SNORT played on  $P_3$  are the same up to relabeling of vertices. This is no coincidence: We will show in Section 3.2 that playing COL and SNORT on a bipartite graph results in isomorphic simplicial complexes.

Also note that this is not true when playing COL and SNORT on  $C_3$ , giving an example of a non-bipartite graph for which the game complexes are not isomorphic.

### 2.3 The Ideals of a Placement Game

Through the monomials that represent legal or illegal positions of a game, we can also associate square-free monomial ideals to a placement game.

**Definition 2.9.** The **legal ideal**,  $\mathcal{L}_{G,B}$ , of a placement game  $G$  played on the board  $B$  is the ideal generated by the monomials representing maximal legal positions of  $G$ .

**Definition 2.10.** The **illegal ideal**,  $\mathcal{ILL}_{G,B}$ , of a placement game  $G$  played on the board  $B$  is the ideal generated by the monomials representing minimal illegal positions of  $G$ .

**Definition 2.11.** The **illegal complex**, sometimes called the **auxiliary board** [6], of a placement game  $G$  played on the board  $B$ , is the simplicial complex whose facets are represented by the monomials of the minimal illegal positions of  $G$ . It is denoted by  $\Gamma_{G,B}$ .

The authors in [6] introduce the auxiliary board for so called “independence placement games”, which is the class of placement games for which the illegal complex is a graph.

**Proposition 2.12.** *For a placement game  $G$  played on a board  $B$  we have the following*

$$(1) \mathcal{L}_{G,B} = \mathcal{F}(\Delta_{G,B}),$$

$$(2) \mathcal{ILL}_{G,B} = \mathcal{F}(\Gamma_{G,B}) = \mathcal{N}(\Delta_{G,B}).$$

*Proof.* (1) The facets of  $\Delta_{G,B}$  represent the maximal legal positions of  $G$ . Thus  $\mathcal{F}(\Delta_{G,B})$  is the ideal generated by the monomials representing the maximal legal positions, which is  $\mathcal{L}_{G,B}$  by definition.

(2) The facets of  $\Gamma_{G,B}$  are represented by the monomials of the minimal illegal positions of  $G$ , which by definition generate  $\mathcal{ILL}_{G,B}$ , proving the first equality.

Since the faces of  $\Delta_{G,B}$  represent the legal positions of  $G$ , the minimal non-faces of  $\Delta_{G,B}$  represent the minimal illegal positions, which generate  $\mathcal{ILL}_{G,B}$ . Thus  $\mathcal{ILL}_{G,B} = \mathcal{N}(\Delta_{G,B})$ .  $\square$

**Example 2.13.** Consider COL played on the path  $P_3$  with labels as in Example 2.2. We then have the legal ideal

$$\mathcal{L}_{\text{COL},P_3} = \langle x_1y_2x_3, y_1x_2y_3, x_1y_3, y_1x_3 \rangle$$

and the illegal ideal

$$\mathcal{ILL}_{\text{COL},P_3} = \langle x_1x_2, x_2x_3, y_1y_2, y_2y_3 \rangle.$$

The illegal complex  $\Gamma_{\text{COL},P_3}$  is given in Figure 2.6.

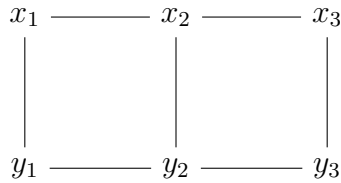
Figure 2.6: The Illegal Complex  $\Gamma_{\text{COL}, P_3}$ 

## 2.4 Playing Games on Simplicial Complexes

Since the facets of the illegal complex represent the minimal illegal positions, we can play on  $\Gamma_{G,B}$ , instead of playing  $G$  on the board  $B$ , according to the following rules:

- Left may only play on vertices labelled  $x_i$ , while Right may only play on vertices labelled  $y_i$ .
- Given a facet, pieces played may not occupy all the vertices of the facet.

Since the facets of  $\Gamma_{G,B}$  are the minimal illegal positions, any vertex set that does not contain all the vertices of any facet is a legal position of  $G$ . Thus playing on  $\Gamma_{G,B}$  according to the above rules results in legal positions.

**Example 2.14.** Consider COL played on  $P_5$ . Since pieces may not be placed on the same space, or pieces by the same player placed side by side, the facets of  $\Gamma_{\text{COL}, P_5}$  then consist of the edges between  $x_i$  and  $y_i$ , between  $x_i$  and  $x_{i+1}$ , and between  $y_i$  and  $y_{i+1}$ . It is given in Figure 2.7.

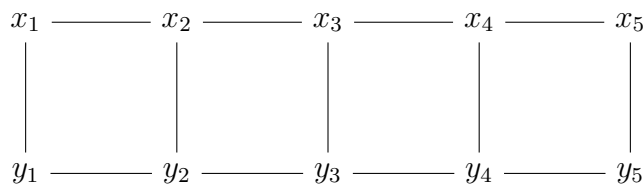
Figure 2.7: The Illegal Complex  $\Gamma_{\text{COL}, P_5}$ 

Then playing on the vertices  $x_1, y_3, x_4, y_5$  is legal since we never have both vertices of an edge. This position is shown on the top of Figure 2.8, while the bottom shows the corresponding position played on  $P_5$ .

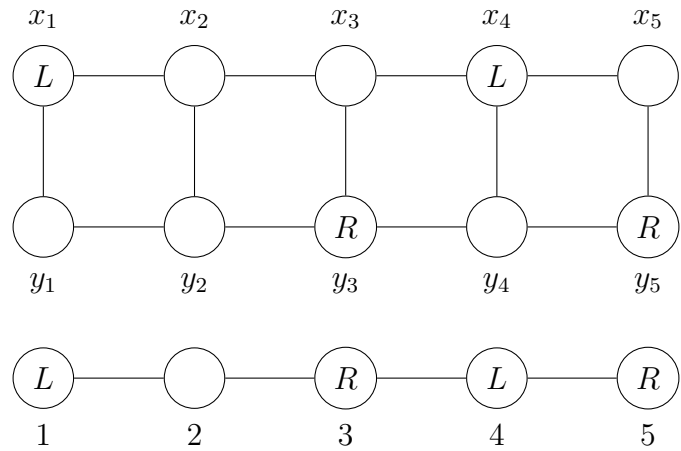

Figure 2.8: A Legal Position on  $\Gamma_{\text{COL}, P_5}$  and on  $P_5$

The illegal complexes of distance games (Chapter 3) and weight games (Chapter 4) are graphs; this will be clear from the setup. To give an example of how to play on an illegal complex with a facet of 3 or more vertices, we will now look at NOGO.

**Example 2.15.** Consider NOGO played on the path  $P_3$ . The legal ideal is

$$\mathcal{L}_{\text{NoGo}, P_3} = \langle x_1x_2, x_1x_3, x_1y_3, x_2x_3, y_1x_3, y_1y_2, y_1y_3, y_2y_3 \rangle$$

while the illegal ideal is

$$\mathcal{ILL}_{\text{NoGo}, P_3} = \langle x_1x_2x_3, y_1y_2y_3, x_1y_1, x_1y_2, x_2y_2, x_2y_3, x_3y_3, y_1x_2, y_2x_3 \rangle.$$

The illegal complex is given in Figure 2.9.

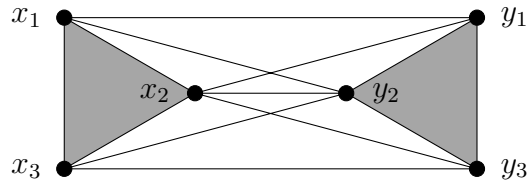

Figure 2.9: The Illegal Complex  $\Gamma_{\text{NoGo}, P_3}$

Then playing on  $x_1$  and  $x_2$  is legal (they form a face, but not a facet), while playing on  $x_1, x_2$ , and  $x_3$  is illegal.

Similarly, playing on the game complex  $\Delta_{G,B}$  according to the following rules is also equivalent to playing  $G$  on  $B$ :

- Left may only play on vertices labelled  $x_i$ , while Right may only play on vertices labelled  $y_i$ .
- For the set  $S$  of vertices occupied,  $S$  needs to be a face of  $\Delta_{G,B}$ .

**Example 2.16.** Consider COL played on  $C_3$ . The game complex is given in Figure 2.4. The position on the left in Figure 2.10 is legal, while the one on the right is illegal when playing on the complex.

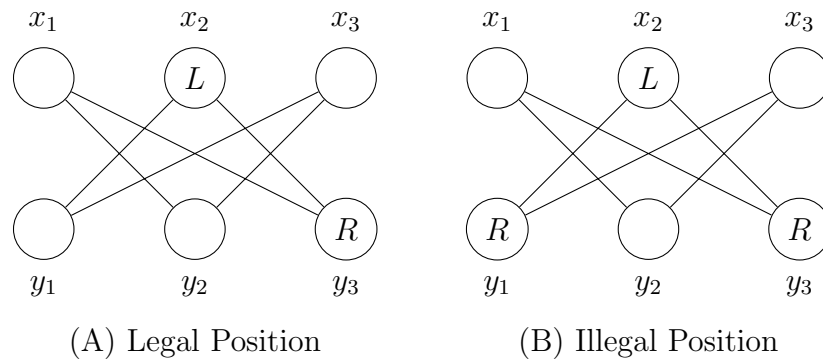

Figure 2.10: A Legal and an Illegal Position when Playing on  $\Delta_{\text{COL},C_3}$

Notice that both the game complex and the illegal complex give a representation of the game *and* the board that it is played on. Thus, we can use the two complexes interchangeably, which is of advantage since sometimes the illegal complex is simpler than the game complex (for example, the game complex of COL played on  $P_5$  has facets with 5 vertices, while in the illegal complex the facets have 2 vertices).

## 2.5 Questions

From the construction of game complexes from placement games, there are several questions that arise naturally.

First, we are interested in a possible reverse construction. In other words, we are looking at what conditions a simplicial complex has to satisfy to be a game complex. Since no vertex can be connected to all other vertices in a game complex (otherwise a Left and a Right piece would occupy the same space - a contradiction to the rule that one may only place on empty spaces), we know that not all simplicial complexes can be game complexes (e.g. a complete graph is not).

Also, we know that some games correspond to isomorphic simplicial complexes (see Examples 2.5 and 2.7). We are interested in what these games have in common with each other.

In addition, we would like to understand what known combinatorial properties of simplicial complexes say about combinatorial games.

To answer the first two questions, in the subsequent chapters we focus on how different boards and different rules influence the corresponding simplicial complex. This also helps with the third question.

## Chapter 3

### Distance Games, the Bipartite Flip, and Doppelgänger

In this chapter, we will introduce distance games, a subclass of placement games in which fixed distances between pieces are illegal. For a specific set of distance games played on bipartite boards, denoted by  $\mathcal{A}$ , we then define a bijective function from  $\mathcal{A}$  to  $\mathcal{A}$ , called the bipartite flip, that maps a distance game  $A$  to a distance game  $B$  such that  $A$  and  $B$  have the same game polynomial. We call two games with the same game polynomial on the same board Doppelgänger, and we will show that for any two distinct games from a specific subset of distance games there exists a board on which they are not Doppelgänger.

#### 3.1 Introduction

**Definition 3.1.** The **distance** between two pieces placed on a graph is the distance between the two vertices containing the pieces. For a game  $G$  let

$$\begin{aligned}L_G &= \{\text{illegal distances between two Left pieces}\}, \\R_G &= \{\text{illegal distances between two Right pieces}\}, \\D_G &= \{\text{illegal distances between different pieces}\}.\end{aligned}$$

If  $L_G = R_G$ , then we define

$$S_G = \{\text{illegal distances between similar pieces}\},$$

i.e.  $S_G := L_G = R_G$ . The sets  $L_G$ ,  $R_G$ ,  $S_G$ , and  $D_G$  are called **distance sets**.

Note that distance sets satisfy universality.

**Example 3.2.** For COL, we have  $D_{\text{COL}} = \emptyset$  and  $S_{\text{COL}} = \{1\}$  since no two pieces by the same player are allowed to be adjacent. Similarly, for SNORT, we have  $S_{\text{SNORT}} = \emptyset$  and  $D_{\text{SNORT}} = \{1\}$ .

**Example 3.3.** Consider a game  $G$  played on the path  $P_5$  in which  $S_G = \{1\}$  and  $D_G = \{2\}$ . The position on the left in Figure 3.1 is then legal, while the one on the right is illegal since the second and third vertex both contain  $R$  even though  $1 \in S_G$  and the second and fourth vertex contain different pieces even though  $2 \in D_G$ .

$$\begin{array}{cc}
 L - R - L - R - L & L - R - R - L - R \\
 \text{(A) Legal position} & \text{(B) Illegal position}
 \end{array}$$

Figure 3.1: Positions of the Distance Game  $G$  with  $S_G = \{1\}$  and  $D_G = \{2\}$

**Definition 3.4.** A placement game is called a **distance game** if its rules consist of distance sets only.

From the definition of a distance game, the following is immediate:

**Lemma 3.5.** *Distance games have universal rulesets.* □

Notice that despite 0 being forbidden as a distance between any two pieces, since we may not play twice on the same vertex, we do not consider 0 an element of these sets.

The distance game in which all distance sets are empty is the TRIVIAL placement game.

COL and SNORT are examples of distance games, while NOGO is a placement game, but not a distance game.

### 3.2 The Bipartite Flip

In this section, the games satisfy  $L_G = R_G = S_G$  and the boards are bipartite graphs with fixed parts  $V_1$  and  $V_2$ .

The class of distance games with  $L_G = R_G$  played on bipartite graphs will be denoted by  $\mathcal{A}$ . We can define a function  $BF_{V_2}$  on  $\mathcal{A}$ . We will first define its effects on a single square-free monomial representing a position, then on a set of monomials, and finally on a game:



**Definition 3.6.** Given a square-free monomial  $x_{i_1} \dots x_{i_m} y_{j_1} \dots y_{j_n}$  we can assume without loss of generality that the indices  $i_1, \dots, i_k$  and  $j_1, \dots, j_l$  belong to  $V_1$ , where  $k \leq m$  and  $l \leq n$ , while the other indices belong to  $V_2$ . We then define

$$BF_{V_2}(x_{i_1} \dots x_{i_m} y_{j_1} \dots y_{j_n}) = x_{i_1} \dots x_{i_k} y_{i_{k+1}} \dots y_{i_m} y_{j_1} \dots y_{j_l} x_{j_{l+1}} \dots x_{j_n}.$$

Essentially, this map ‘flips’  $x$  and  $y$  for the vertices in  $V_2$ .

**Definition 3.7.** Given a set of square-free monomials  $\{m_1, \dots, m_t\}$ , we define  $BF_{V_2}(m_1, \dots, m_t) = \{BF_{V_2}(m_1), \dots, BF_{V_2}(m_t)\}$ .

**Definition 3.8.** For a game  $G \in \mathcal{A}$  whose legal positions are represented by a set of square-free monomials  $\{m_1, \dots, m_t\}$ , we define  $BF_{V_2}(G)$  to be the game whose legal positions are represented by the square-free monomials  $BF_{V_2}(m_1, \dots, m_t) = \{BF_{V_2}(m_1), \dots, BF_{V_2}(m_t)\}$ .

For now, we do not assume that  $BF_{V_2}(G)$  is a distance game, thus automatically satisfying universality, but we will show this in Proposition 3.13.

**Example 3.9.** Consider COL played on  $P_3$  with parts  $V_1 = \{1, 3\}$  and  $V_2 = \{2\}$ . The monomials representing legal positions are given in Example 2.3. The maximal monomial  $x_1 y_2 x_3$  is mapped by  $BF_{V_2}$  to  $x_1 x_2 x_3$ , and similarly for all other monomials. Thus  $BF_{V_2}(\text{COL})$  is

$$\begin{aligned} & BF_{V_2}(0, x_1, x_2, x_3, y_1, y_2, y_3, x_1 x_3, y_1 y_3, x_1 y_2, x_1 y_3, y_1 x_2, y_1 x_3, x_2 y_3, y_2 x_3, x_1 y_2 x_3, y_1 x_2 y_3) \\ &= \{0, x_1, y_2, x_3, y_1, x_2, y_3, x_1 x_3, y_1 y_3, x_1 x_2, x_1 y_3, y_1 y_2, y_1 x_3, y_2 y_3, x_2 x_3, x_1 x_2 x_3, y_1 y_2 y_3\} \end{aligned}$$

Note that this is SNORT played on  $P_3$ .

**Proposition 3.10.** For a game  $G \in \mathcal{A}$ , we have  $BF_{V_1}(G) = BF_{V_2}(G)$ .

*Proof.* Since  $L_G = R_G$  it follows easily that if  $x_{i_1} \dots x_{i_m} y_{j_1} \dots y_{j_n}$  is a legal position in  $G$ , then  $y_{i_1} \dots y_{i_m} x_{j_1} \dots x_{j_n}$  is also a legal position. Thus

$$\begin{aligned} BF_{V_2}(x_{i_1} \dots x_{i_m} y_{j_1} \dots y_{j_n}) &= x_{i_1} \dots x_{i_k} y_{i_{k+1}} \dots y_{i_m} y_{j_1} \dots y_{j_l} x_{j_{l+1}} \dots x_{j_n} \\ &= BF_{V_1}(y_{i_1} \dots y_{i_m} x_{j_1} \dots x_{j_n}) \end{aligned}$$

assuming without loss of generality that the indices  $i_1, \dots, i_k$  and  $j_1, \dots, j_l$  belong to  $V_1$ , where  $k \leq m$  and  $l \leq n$ , while the other indices belong to  $V_2$ . This shows that

the monomials of  $BF_{V_1}(G)$  are the same as the monomials of  $BF_{V_2}(G)$ , proving the equality of the two games.  $\square$

As a consequence of this, when applying the map  $BF_{V_2}$  to a game  $G \in \mathcal{A}$ , we will sometimes drop the subscript.

**Definition 3.11.** The map  $BF_{V_2}$  applied to a monomial, the map  $BF_{V_2}$  applied to a set of monomials, and the map  $BF_{V_2}$  on  $\mathcal{A}$  are all called the **bipartite flip**.

It will be clear from context which version of the bipartite flip we are using.

**Proposition 3.12.** *The bipartite flip  $BF_{V_2}$  on sets of monomials is bijective.*

*Proof.* We claim that for any set of monomials  $M = \{m_1, \dots, m_t\}$  with the board partitioned by  $V_1$  and  $V_2$  we have  $BF_{V_2}(BF_{V_2}(M)) = M$ , that is  $BF_{V_2}$  is an involution. Take any monomial

$$x_{i_1} \dots x_{i_k} x_{i_{k+1}} \dots x_{i_m} y_{j_1} \dots y_{j_l} y_{j_{l+1}} \dots y_{j_n}$$

in  $M$  with  $i_1, \dots, i_k, j_1, \dots, j_l \in V_1$  and the remaining indices in  $V_2$ . This monomial corresponds to the monomial

$$x_{i_1} \dots x_{i_k} y_{i_{k+1}} \dots y_{i_m} y_{j_1} \dots y_{j_l} x_{j_{l+1}} \dots x_{j_n}$$

in  $BF_{V_2}(M)$ . Applying the bipartite flip again, we get the original monomial.

Thus the monomials of  $M$  are the same as the monomials of  $BF_{V_2}(BF_{V_2}(M))$ , proving the claim. It follows that the bipartite flip is its own inverse, and thus bijective.  $\square$

We remark that the proof to Proposition 3.12 also shows that no two distinct monomials can be mapped to the same monomial by the bipartite flip.

We will now show that for a game  $G \in \mathcal{A}$ ,  $BF(G)$  belongs to  $\mathcal{A}$  as well.

Given a game  $G$  in  $\mathcal{A}$ , consider the appearance of indices representing vertices in the monomials of legal positions: Since  $G$  is a placement game, any index can appear at most once in the monomial of a legal position, and since applying the bipartite flip does not change indices, they also appear at most once in a monomial of a legal position of  $BF_{V_2}(G)$ . Thus pieces are always placed on empty vertices in  $BF_{V_2}(G)$ .

Since placing a piece in  $G$  at a certain point during play implies that it must have been legal before, this is also true for  $BF_{V_2}(G)$ . Thus if we show that the rules of  $BF_{V_2}(G)$  satisfy the universality condition, we will have shown that  $BF_{V_2}(G)$  is also a placement game.

Now consider a distance game  $G$  in  $\mathcal{A}$  with distance sets  $S_G$  and  $D_G$  played on a bipartite graph with parts  $V_1$  and  $V_2$ , and let  $H = BF_{V_2}(G)$ .

Choose any two vertices  $a$  and  $b$  of the board. Since the board is bipartite, the vertices along any path between  $a$  and  $b$  alternately belong to  $V_1$  or  $V_2$ . Thus we have the following: If the distance between  $a$  and  $b$  is even, then either they both belong to  $V_1$  or they both belong to  $V_2$ . If the distance between  $a$  and  $b$  is odd, then one belongs to  $V_1$  and the other belongs to  $V_2$ . This implies:

*If  $d \in S_G$  is even, then  $d \in S_H$ , and similarly if  $d \in D_G$  even, we have  $d \in D_H$ .*

*If  $d \in S_G$  is odd, then  $d \in D_H$ , and if  $d \in D_G$  is odd, then  $d \in S_H$ .*

**Proposition 3.13.** *If  $G$  is an element of  $\mathcal{A}$ , then  $H = BF(G)$  also belongs to  $\mathcal{A}$ , i.e. the bipartite flip goes from  $\mathcal{A}$  to  $\mathcal{A}$ . The distance sets of  $H$  are*

$$S_H = \{d \in S_G \mid d \text{ even}\} \cup \{d \in D_G \mid d \text{ odd}\}$$

$$D_H = \{d \in S_G \mid d \text{ odd}\} \cup \{d \in D_G \mid d \text{ even}\}.$$

*Proof.* Let  $A = \{d \in S_G \mid d \text{ even}\} \cup \{d \in D_G \mid d \text{ odd}\}$  and  $B = \{d \in S_G \mid d \text{ odd}\} \cup \{d \in D_G \mid d \text{ even}\}$ , so that  $A \cup B = S_G \cup D_G$ . From the above argument, we know  $A \subseteq S_H$  and  $B \subseteq D_H$ .

Since by the proof to Proposition 3.12 the monomials representing legal positions of  $G$  and  $H$  are in a one-to-one correspondence through the bipartite flip, we know that the two games have the same number of monomials. Since any element added to a distance set makes more positions illegal, if there would be a  $0 < d \in S_H \setminus A$  (resp.  $0 < d \in D_H \setminus B$ ), then  $H$  would have less monomials representing legal positions than  $G$ , a contradiction. Thus  $A = S_H$  and  $B = D_H$ .

This argument further shows that  $H$  cannot have any more rules than the distance sets (since they would make additional positions illegal). Furthermore, distance sets satisfy universality since by definition they hold for every vertex of the board. Therefore  $H$  is a distance game with  $L_H = R_H$ , played on the same board as  $G$ . Thus we have shown that  $H$  belongs to  $\mathcal{A}$ .  $\square$

**Corollary 3.14.** *The bipartite flip  $BF$  on  $\mathcal{A}$  is bijective.*

*Proof.* Follows directly from Propositions 3.12 and 3.13.  $\square$

Proposition 3.13 also shows that we can find  $S_H$  and  $D_H$  without having to construct every legal position of  $H$ .

**Example 3.15.** Consider the game  $G$  given in Example 3.3. Let  $H = BF(G)$ . Then since  $S_G = \{1\}$  and  $D_G = \{2\}$ , we have  $S_H = \emptyset$  and  $D_H = \{1, 2\}$ .

Note that we cannot apply the bipartite flip to a distance game  $G$  in which  $L_G \neq R_G$  since the resulting game would not satisfy the universality condition. For example, consider the distance game  $G$  with  $L_G = \{2, 3\}$ ,  $R_G = \{1, 2\}$ ,  $D_G = \{1\}$  played on the path  $P_4$ . Then  $x_1x_4$  represents an illegal position, while  $y_1y_4$  is a legal position. Applying the flip to these monomials with  $V_2 = \{2, 4\}$ , we have  $x_1y_4$  is illegal in  $BF_{V_2}(G)$ , while  $y_1x_4$  is legal. The first would imply  $3 \in D_{BF_{V_2}(G)}$ , while the second implies  $3 \notin D_{BF_{V_2}(G)}$ , a contradiction.

Also note that we cannot generalize the bipartite flip to non-bipartite boards since the resulting game would not necessarily satisfy universality. For example, consider COL played on  $C_3$  (see Example 2.6) and partition the board as  $V_1 = \{1, 3\}$  and  $V_2 = \{2\}$ . Then flipping the pieces on the vertices in  $V_2$ , we have the game whose maximal monomials are

$$\{x_1x_2, x_1y_3, y_1x_3, y_1y_2, x_2x_3, y_2y_3\}.$$

Thus two Left pieces may be adjacent on vertices 1 and 2, and vertices 2 and 3, but not on vertices 1 and 3, a contradiction to universality.

Now consider the game complex of any game  $G$  in  $\mathcal{A}$  and the game complex of the corresponding game  $BF(G)$ . Since the bipartite flip only relabels ( $x_i$  to  $y_i$  and conversely for all indices  $i$  in one of the parts of the board), it has the same effect on the vertices of the simplicial complexes. Thus the complexes of the two games are the same up to relabeling. This proves the first half of the following Lemma:

**Lemma 3.16.** *For a game  $G \in \mathcal{A}$ , we have  $\Delta_{G,B} \cong \Delta_{BF(G),B}$  and  $\Gamma_{G,B} \cong \Gamma_{BF(G),B}$ .*

*Proof.* Using Proposition 2.12 and that the facet (resp. Stanley-Reisner) operators are inverses of each other, thus bijective, we have

$$\Gamma_{G,B} = \mathcal{F}(\mathcal{N}(\Delta_{G,B})) \cong \mathcal{F}(\mathcal{N}(\Delta_{BF(G),B})) = \Gamma_{BF(G),B}. \quad \square$$

Proposition 3.13 also shows that COL and SNORT are the bipartite flips of each other when played on a bipartite board, implying by Lemma 3.16 that their simplicial complexes are isomorphic to each other in this case.

**Example 3.17.** Consider COL played on  $P_5$ . The auxiliary board is given in Figure 2.7.

When applying the bipartite flip, then the illegal complex changes to the one given in Figure 3.2, which is the illegal complex for SNORT played on  $P_5$ .

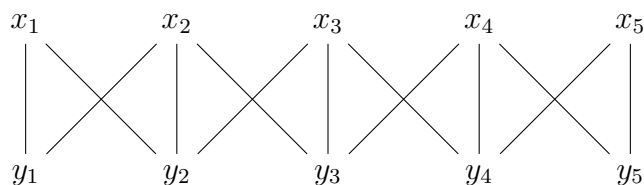

Figure 3.2: The Illegal Complex  $\Gamma_{\text{SNORT}, P_5}$

### 3.3 Doppelgänger

In this section, we will assume  $L_G = R_G = S_G$ . As in the previous section, let  $\mathcal{A}$  be the set of distance games played on a bipartite graph, and let  $BF$  be the bipartite flip on  $\mathcal{A}$ .

**Definition 3.18.** Two distinct games  $G$  and  $H$  are called **Doppelgänger** on a set of boards  $\mathcal{B}$  (or  $\mathcal{B}$ -Doppelgänger) if they have the same game polynomial, i.e.  $P_{G,B}(x) = P_{H,B}(x)$  (see Definition 2.1), for all  $B \in \mathcal{B}$ .

The term Doppelgänger is German (literally translated it means “double goer”) and usually indicates two people that are look-alikes to the extent that they cannot be kept apart from their physical appearance. Since two Doppelgänger in terms of games cannot be distinguished through their game polynomials, this term accurately represents the concept. (On a side note: Doppelgänger is both singular and plural.)

Even though we can define Doppelgänger for any placement games, we will only consider distance games in what follows.

**Proposition 3.19.** *Given a game  $G$  in  $\mathcal{A}$ , let  $H = BF(G)$ . Then  $G$  and  $H$  are Doppelgänger on bipartite graphs.*

*Proof.* By Lemma 3.16, we know for bipartite boards  $B$  that  $\Delta_{G,B} \cong \Delta_{H,B}$ . Since  $f_i(G, B)$  is the number of faces with  $i$  vertices in  $\Delta_{G,B}$  and similarly for  $f_i(H, B)$ , it follows directly that  $f_i(G, B) = f_i(H, B)$  for all  $i$ , i.e.  $G$  and  $H$  are Doppelgänger on  $B$ .  $\square$

**Example 3.20.** We have shown in the previous section that when played on a bipartite board, COL and SNORT are the bipartite flip of each other. Thus COL and SNORT are Doppelgänger on all bipartite boards. This was also shown in [6].

We are interested in whether there are any two placement games that are Doppelgänger on the set of all possible boards. We will partially answer this in the following theorem.

**Theorem 3.21.** *Let  $G$  and  $H$  be two distinct distance games satisfying  $L_G = R_G$  and  $L_H = R_H$ . Then there is a board on which they are not Doppelgänger.*

*Proof.* Let  $G$  and  $H$  be two distinct distance games, i.e.  $S_G \neq S_H$  or  $D_G \neq D_H$ . Let the distance sets be given by  $S_G = \{g_1, g_2, \dots\}$ ,  $S_H = \{h_1, h_2, \dots\}$ ,  $D_G = \{g'_1, g'_2, \dots\}$ , and  $D_H = \{h'_1, h'_2, \dots\}$ , where  $g_1 < g_2 < \dots$  and similarly for the other distance sets. If  $S_G \neq S_H$ , let  $i$  be the smallest index such that  $g_i \neq h_i$ . Similarly, if  $D_G \neq D_H$ , let  $j$  be the smallest such that  $g'_j \neq h'_j$ . There are several cases to consider, and we will show for each that a board exists on which  $G$  and  $H$  are not Doppelgänger.

Case 1 ( $S_G \neq S_H$  and  $D_G = D_H$ ): Assume without loss of generality that  $g_i < h_i$ . Now consider the games  $G$  and  $H$  played on the path  $P_{g_i+1}$ . Since  $\text{diam}(P_{g_i+1}) = g_i$ , no two pieces will have a distance greater than  $g_i$  and we can ignore any elements in the distance sets greater than  $g_i$ . Thus essentially  $S_G = S_H \cup \{g_i\}$ . Then since  $D_G = D_H$  every position with two pieces that is legal in  $G$  is also legal in  $H$ . On the other hand though,  $x_1x_{g_i+1}$  and  $y_1y_{g_i+1}$  are legal positions of  $H$ , but not of  $G$ . Thus  $f_2(H) = f_2(G) + 2$ , proving that  $G$  and  $H$  are not Doppelgänger.

Case 2 ( $S_G = S_H$  and  $D_G \neq D_H$ ): Assuming without loss of generality that  $g'_j < h'_j$ , we can repeat the argument from the previous case by playing on  $P_{g'_j+1}$ . Then

the monomials  $x_1y_{g'_i+1}$  and  $y_1x_{g'_i+1}$  are legal for  $H$ , but not for  $G$ , while all other monomials are in common. Thus  $f_2(H) = f_2(G) + 2$ .

Case 3 ( $S_G \neq S_H$  and  $D_G \neq D_H$ ): There are 3 subcases to consider:

Case 3a ( $g_i < h_i$  and  $g'_j < h'_j$ ): Let  $m = \min\{g_i, g'_j\}$ . Then repeat the argument of the first case on the path  $P_{m+1}$ , and observe that the monomials  $x_1x_{m+1}$  and  $y_1y_{m+1}$  are legal for  $H$  but not for  $G$  if  $m = g_i$ , and  $x_1y_{m+1}$  and  $y_1x_{m+1}$  are legal for  $H$  but not for  $G$  if  $m = g'_j$ , while all other monomials are in common. Thus  $f_2(H) > f_2(G)$ .

Case 3b ( $g_i < h_i$  and  $g'_j > h'_j$  with  $g_i \neq h'_j$ ): Let  $m = \min\{g_i, h'_j\}$ . Then repeat the argument of the first case on the path  $P_{m+1}$ , and observe that the monomials  $x_1x_{m+1}$  and  $y_1y_{m+1}$  are legal for  $H$  but not for  $G$  if  $m = g_i$ , and  $x_1y_{m+1}$  and  $y_1x_{m+1}$  are legal for  $G$  but not for  $H$  if  $m = h'_j$ , while all other monomials are in common. Thus  $f_2(H) \neq f_2(G)$ .

Case 3c ( $g_i < h_i$  and  $g'_j > h'_j$  with  $g_i = h'_j$ ): If  $g_i = 2m$  is even, then we consider the board in Figure 3.3(A), which consists of three paths of length  $m + 1$  joined in one end vertex, i.e. the distance between any of the vertices  $a$ ,  $b$ , or  $c$  to the center vertex is  $m$ . If  $g_i = 2m + 1$  is odd, we consider the board in Figure 3.3(B), which consists of a cycle of length 3, with a path of length  $m + 1$  joined on each vertex. Since the diameter of both graphs is  $g_i$ , we can again ignore all distances greater than  $g_i$ . Thus essentially  $S_G = S_H \cup \{g_i\}$  and  $D_G \cup \{g_i\} = D_H$ .

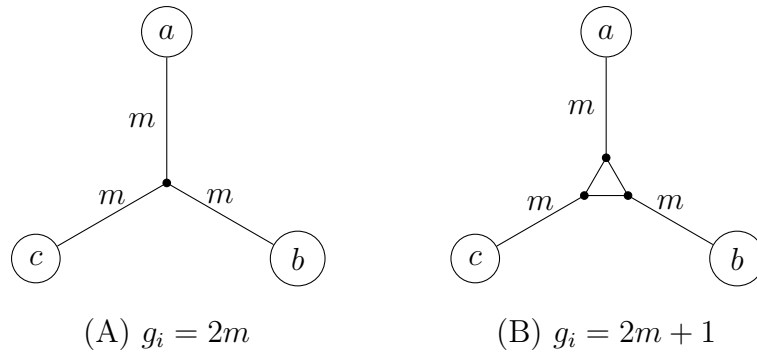

Figure 3.3: Proof of Theorem 3.21: Boards for Case 3c

We will look at the positions involving three pieces played. Triples involving at most one of the vertices  $a$ ,  $b$ , or  $c$  will have all distances between the pieces less than  $g_i$ , thus such a triple is a legal position of  $G$  if and only if it is a legal position of  $H$ . Let the number of triples with none of these vertices be  $K_0$  and the number of triples involving one be  $K_1$ .

Now consider the number of triples involving two of the vertices  $a$ ,  $b$ , and  $c$ . Let  $a_k$  be the vertex that has distance  $k$  from the vertex  $a$  where  $k \leq m$  (i.e.  $a_k$  is on the same ‘branch’ as  $a$ ) and similarly for  $b_k$  and  $c_k$ . For the case  $g_i = 2m$ , we have  $a_m = b_m = c_m$ .

If  $d_a e_b f_{a_k}$  is a legal position for one of the games, where  $d, e, f \in \{x, y\}$ , then through rotation and due to symmetry of the board we get the two legal positions  $d_b e_c f_{b_k}$  and  $d_c e_a f_{c_k}$  for that game; and similarly if  $d_a e_b f_{b_k}$  or  $d_a e_b f_{c_k}$  are legal, we get two more legal positions through rotation. Thus we can partition the number of such triples into equivalence classes where each equivalence class is of the form

$$\{d_a e_b f_{a_k}, d_b e_c f_{b_k}, d_c e_a f_{c_k}\}, \{d_a e_b f_{b_k}, d_b e_c f_{c_k}, d_c e_a f_{a_k}\},$$

or

$$\{d_a e_b f_{c_k}, d_b e_c f_{a_k}, d_c e_a f_{b_k}\}.$$

This shows that the number of triples with pieces on two of the vertices  $a$ ,  $b$ , or  $c$ , has to be divisible by 3, thus let the number of such triples in  $G$  be  $3K_2$  and in  $H$  be  $3K'_2$ .

In  $G$ , no triple involving all three vertices  $a$ ,  $b$ , and  $c$  is possible. For a contradiction, assume without loss of generality that Left has played on vertex  $a$ . Then since the distance between  $a$  and  $b$  is  $g_i$  and  $g_i \in S_G$ , we know that Left cannot play on  $b$ , thus we can assume Right has played on  $b$ . Similarly, we can assume Right has played on  $c$ . Since the distance between  $b$  and  $c$  is  $g_i$ , this would force  $g_i \notin S_G$ , a contradiction. In  $H$  though, the triples  $x_a x_b x_c$  and  $y_a y_b y_c$  are legal.

Looking at the total number of triples in  $G$  and  $H$ , we have  $f_2(G) = K_0 + K_1 + 3K_2 + 0$  and  $f_2(H) = K_0 + K_1 + 3K'_2 + 2$  (see Table 3.1). Considering



# of vertices of $\{a, b, c\}$ used	Number of triples in	
	$G$	$H$
0	$K_0$	$K_0$
1	$K_1$	$K_1$
2	$3K_2$	$3K'_2$
3	0	2

Table 3.1: Proof of Theorem 3.21: Number of Triples for Case 3c

these modulo 3, we have  $f_2(G) \equiv_3 K_0 + K_1$  and  $f_2(H) \equiv_3 K_0 + K_1 + 2$ , which shows  $f_2(G) \neq f_2(H)$ . Thus  $G$  and  $H$  are not Doppelgänger.

□

## Chapter 4

### Kruskal-Katona Type Bounds for Weight Games

This chapter begins by giving an overview of the Kruskal-Katona theorem, which determines when a vector of non-negative integers is the  $f$ -vector of a simplicial complex. Similarly, we would like to find both necessary and sufficient conditions for such a vector to be the  $f$ -vector of a game complex.

We will then introduce the notion of the weight of a piece, and will study how different weights and different boards influence the game complex by finding upper bounds on the entries of the  $f$ -vector, thus giving necessary conditions reminiscent of the Kruskal-Katona theorem.

#### 4.1 The Kruskal-Katona Theorem

Recall that  $\binom{a}{0} = 1$  and  $\binom{a}{b} = 0$  if  $b > a$ .

Kruskal [15] and Katona [14] proved that for each pair of non-negative integers  $f$  and  $i$ ,  $f$  can be written in the form

$$f = \binom{n_i}{i} + \binom{n_{i-1}}{i-1} + \dots + \binom{n_{i-s}}{i-s}$$

where  $n_i > n_{i-1} > \dots > n_{i-s} \geq i - s \geq 1$  are unique. This sum is called the  **$i$ -canonical representation of  $f$** .

We can then define the  **$j$ th pseudopower of  $f$**

$$f_i^{(j)} = \binom{n_i}{j} + \binom{n_{i-1}}{j-1} + \dots + \binom{n_{i-s}}{j-s}$$

for  $j \geq 1$ .

The Kruskal-Katona theorem gives necessary and sufficient conditions for a vector  $(f_0, f_1, \dots, f_k)$  with entries from the non-negative integers to be the  $f$ -vector of a simplicial complex. The following is the version proven by Kruskal:

**Theorem 4.1** (Kruskal [15]). *For the sequence of non-negative integers  $(f_0, f_1, \dots, f_k)$  the following are equivalent:*

- (i)  $(f_0, f_1, \dots, f_k)$  is the  $f$ -vector of a non-empty simplicial complex;
- (ii)  $f_0 = 1$  and  $f_j \leq f_i^{(j)}$  for all  $1 \leq i \leq j$ ;
- (iii)  $f_0 = 1$  and  $f_j \geq f_i^{(j)}$  for all  $1 \leq j \leq i$ .

To show that (ii) holds, it is sufficient to show that  $f_0 = 1$  and  $f_{i+1} \leq f_i^{(i+1)}$  for all  $i \geq 1$  since all other cases follow. Similarly, to show (iii), showing  $f_0 = 1$  and  $f_j \geq f_{j+1}^{(j)}$  for all  $j \geq 1$  is sufficient. The Kruskal-Katona theorem is usually stated in terms of either one of these.

We start our discussion by stating that not every simplicial complex is a game complex.

**Lemma 4.2.** *Not every simplicial complex is the game complex of a placement game.*

*Proof.* Consider any placement game  $G$  and its game complex  $\Delta_G$ . Since  $x_i y_i$  is illegal in  $G$ , the two vertices  $x_i$  and  $y_i$  cannot be connected by an edge in  $\Delta_G$ . This implies that if  $\Delta_G$  has  $v$  vertices, then every vertex can be connected to at most  $v - 2$  vertices. But we know that simplicial complexes exist in which a vertex is connected to all other vertices (for example a complete graph).  $\square$

## 4.2 Games with Weight

In the remainder, we will consider playing pieces of larger size. Specifically, we call the number of connected vertices a piece covers the **weight** of this piece.

For example, in CROSSGRAM [11] and **Domineering** [3] the pieces are dominoes and are being placed on a checker-board. For us, they are weight 2.

**Example 4.3.** Consider the board given in Figure 4.1. A piece that has weight 4 could for example be played on the vertex set  $\{1, 2, 3, 4\}$ , but not on the vertex set  $\{1, 3, 5, 6\}$  since these vertices are not connected.

Many placement games have weights greater than 1. For example, in DOMINEERING Left and Right both play pieces of weight 2 and, as we will mention in Remark 4.14, partizan octal games are equivalent to placement games on a path with weight.

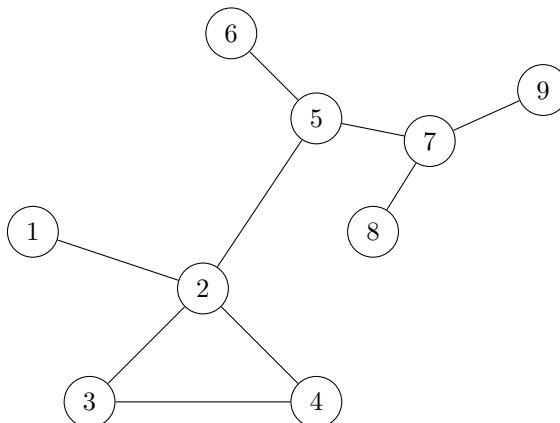

Figure 4.1: An Example Board

In the monomials representing a legal position, the Left piece of weight  $a$  occupying the vertices labeled  $i_1, \dots, i_a$  will be indicated by  $x_{i_1, \dots, i_a}$ , and similarly for Right pieces.

We usually assume that every piece of Left has the same weight  $a$ , and every piece of Right has the same weight  $b$ . Whenever we assign sets of weights to Left and Right, i.e. Left can play pieces of weight  $\{a_1, \dots, a_k\}$  and Right can play pieces of weight  $\{b_1, \dots, b_l\}$ , the upper bounds on the number of positions are the same as in a game with  $k + l$  players in which player  $i$  plays pieces of weight  $a_i$  for  $1 \leq i \leq k$  and of weight  $b_{i-k}$  for  $k < i \leq k + l$ . The  $t$ -player versions of the upper bounds will be given in each section after the 2-player version.

**Definition 4.4.** A placement game in which the players play pieces of fixed weights is called a **game with weights**. If the game has no rules besides pieces having to be placed on connected sets of empty vertices, we call it a **weight game**. A 2-player weight game will be denoted by  $W(a, b)$  where  $a$  is the weight (or set of weights) that Left plays, while  $b$  is the weight (or set of weights) that Right plays. The  $t$ -player weight game where player  $i$  plays weight  $a_i$  is denoted by  $W(a_1, \dots, a_t)$ .

Essentially, the weight game is the TRIVIAL placement game with weights. It is also interesting to note the following.

**Proposition 4.5.** *On a path  $P_n$  (resp. a cycle  $C_n$ ), the weight game  $W(a, a)$  in which Left and Right play the same weight is equivalent to a distance game  $H$  on  $P_{n-a+1}$  (resp.  $C_n$ ) with  $S_H = D_H = \{1, 2, \dots, a - 1\}$ .*

Before proving this, we will demonstrate via an example:

**Example 4.6.** Let  $G$  be the weight game  $W(3, 3)$  played on the path  $P_6$ . Let  $x_{i,j,k}$  indicate a piece that occupies vertices  $i, j = i + 1$ , and  $k = i + 2$ , i.e. has its leftmost end on vertex  $i$ , and similarly for  $y_{i,j,k}$ . The maximal legal positions are then represented by

$$\{x_{1,2,3}x_{4,5,6}, x_{1,2,3}y_{4,5,6}, y_{1,2,3}x_{4,5,6}, y_{1,2,3}y_{4,5,6}, x_{2,3,4}, x_{3,4,5}, y_{2,3,4}, y_{3,4,5}\}.$$

We will now relabel the indices by mapping the index  $\{i, i + 1, i + 2\}$  to the index  $i$ . The maximal legal positions are then represented by the monomials

$$\{x_1x_4, x_1y_4, y_1x_4, y_1y_4, x_2, x_3, y_2, y_3\}.$$

These maximal monomials are the same as for a distance game  $H$  played on the path  $P_4$  with distance sets  $S_H = D_H = \{1, 2\}$ . For example, consider the position  $x_{1,2,3}y_{4,5,6}$  in  $G$ , equivalent to  $x_1y_4$  in  $H$  (see Figure 4.2).

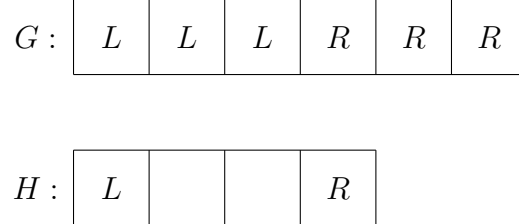

Figure 4.2: The Position  $x_{1,2,3}y_{4,5,6}$  in  $G$  and  $x_1y_4$  in  $H$

*Proof of Proposition 4.5.* In the case that we are playing on a path or cycle, a piece of weight  $a$  will be a strip, i.e. there exists an integer  $i$  such that the piece occupies the vertices  $i, i + 1, \dots, i + a - 1 \pmod n$  on the cycle).

Now consider a monomial representing a legal position in the game  $W(a, a)$ . Every index may appear at most once since we are not allowed to play on occupied vertices. Thus if  $d_{i,\dots,i+a-1}e_{j,\dots,j+a-1}$  with  $d, e \in \{x, y\}$  is legal in  $W(a, a)$ , then the distance between the vertices  $i$  and  $j$  has to be greater or equal to  $a$ .

We now construct a game  $H$  with pieces of weight 1 that is equivalent to  $W(a, a)$  by mapping the index set  $\{i, \dots, i + a - 1\}$  of monomials in  $W(a, a)$  to the index  $i$  for monomials in  $H$ . Since the only condition in  $H$  is that indices need distance at least

$a$ , we have that  $H$  is a distance game with distance sets  $S_H = D_H = \{1, 2, \dots, a-1\}$ . Also note that if we play  $W(a, a)$  on  $P_n$  then  $i + a - 1 \leq n$  implies that  $i \leq n - a + 1$  such that  $H$  is played on  $P_{n-a+1}$ . If we play  $W(a, a)$  on  $C_n$ , then  $i$  can be any value from 1 to  $n$ , so  $H$  is played on  $C_n$  as well.  $\square$

If the weight of the Left pieces is  $a$  and the weight of the Right pieces  $b$ , then we will be able to place more pieces of the player that plays the smaller weight onto the board than of the player with the larger weight. Specifically, assuming without loss of generality that  $a$  is smaller, we would be able to place at most  $\lfloor n/a \rfloor$  Left pieces on a board of  $n$  vertices. If we place a mix of Left and Right pieces or just Right pieces, the number of pieces we are able to place will be equal or less. Thus if the  $f$ -vector of the game complex is  $(f_0, f_1, \dots, f_k)$ , then

$$k \leq \max\{\lfloor n/a \rfloor, \lfloor n/b \rfloor\}.$$

**Proposition 4.7.** *For simplicial complexes corresponding to games on any board of  $n$  vertices with pieces of weight 1, we have*

$$f_i \leq \binom{n}{i} 2^i$$

for  $i \geq 0$ .

*Proof.* We will consider the number of positions with  $i$  pieces of weight 1 in the placement game that has no additional rules, i.e. the TRIVIAL placement game. As we add rules to this game to get other placement games with pieces of weight 1, the number of positions decreases, thus the number of such positions in TRIVIAL gives the maximum. In TRIVIAL, there are  $\binom{n}{i}$  ways to choose  $i$  spaces to place pieces, for each there are 2 choices: either a Left piece, or a Right piece. Our claim now follows.  $\square$

This is easily generalized to a  $t$ -player version:

**Corollary 4.8.** *For a simplicial complex corresponding to a  $t$ -player game on any board of  $n$  vertices with pieces of weight 1, we have*

$$f_i \leq \binom{n}{i} t^i$$

for  $i \geq 0$ .  $\square$

We will now look at how playing pieces of specified weight on different classes of boards influences the  $f$ -vector of the corresponding game complex. The classes of boards we specifically look at are paths, cycles, complete graphs, and complete bipartite graphs.

Note that the  $f$ -vector of a weight game gives an upper bound on the  $f$ -vector of a game with the same weights. Thus the formulae for the weight games in the following sections give bounds for the games with weight.

### 4.3 Playing on the Path $P_n$

Consider Left playing pieces of weight  $a$  and Right pieces of weight  $b$  on the path  $P_n$ ,  $n \geq 1$ .

**Proposition 4.9.** *If a simplicial complex corresponds to a weight game  $W(a, b)$  played on  $P_n$  then*

$$f_1 = \begin{cases} 0 & \text{if } a, b > n, \\ n - a + 1 & \text{if } a \leq n \text{ and } b > n, \\ n - b + 1 & \text{if } a > n \text{ and } b \leq n, \\ 2n - a - b + 2 & \text{if } a, b \leq n. \end{cases} \quad (4.1)$$

*Proof.* We are measuring the number of legal positions with only one piece on the board. If  $n \geq a$ , then placing one piece of weight  $a$  on a strip of length  $n$  is equivalent to placing one piece of weight 1 (think of the left-most end of the piece) on a strip of length  $n - (a - 1) = n - a + 1$ , so the second and third case follow. Similarly, for the final case

$$\begin{aligned} f_1 &= (n - a + 1) + (n - b + 1) \\ &= 2n - a - b + 2. \end{aligned}$$

□

**Proposition 4.10.** *In a weight game  $W(a, b)$  played on  $P_n$ , the number of positions with two Left pieces or two Right pieces, respectively, is*

$$N_{LL} = \begin{cases} 0 & \text{if } 2a > n, \\ \binom{n-2a+2}{2} & \text{if } 2a \leq n; \end{cases} \quad N_{RR} = \begin{cases} 0 & \text{if } 2b > n, \\ \binom{n-2b+2}{2} & \text{if } 2b \leq n. \end{cases}$$

The number of positions with one Left and one Right piece is

$$N_{LR} = \begin{cases} 0 & \text{if } a + b > n, \\ 2^{\binom{n-a-b+2}{2}} & \text{if } a + b \leq n. \end{cases}$$

For the game complex of such a game we have

$$f_2 = N_{LL} + N_{RR} + N_{LR}. \quad (4.2)$$

*Proof.* To find  $N_{LR}$  when  $n \geq a + b$ , we only consider the case in which the Left piece is the left-most piece. The other case is symmetric. We will first place the Left piece in position  $i$ . To be able to fit a Right piece to the right of this, we have  $1 \leq i \leq n - a - b + 1$ . The strip to the right then has length  $n - (i + a - 1) = n - a + 1 - i$

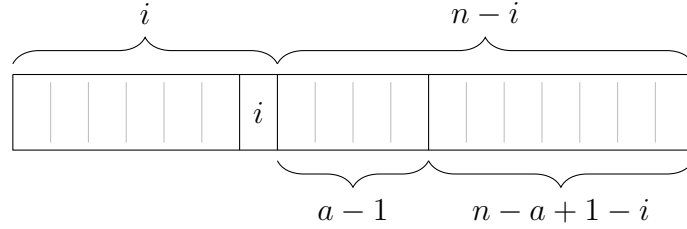

Figure 4.3: Proof to Proposition 4.10: Placing a Piece of Weight  $a$  on a Path

(see Figure 4.3). Thus we have  $n - a + 1 - i - (b - 1) = n - a - b + 2 - i$  choices to place the Right piece (see Proposition 4.9). Thus the number of position with Left on the left and Right on the right is

$$\begin{aligned} & \sum_{i=1}^{n-a-b+1} (n - a - b + 2 - i) \\ &= (n - a - b + 1)(n - a - b + 2) - \sum_{i=1}^{n-a-b+1} i \\ &= (n - a - b + 1)(n - a - b + 2) - \frac{(n - a - b + 1)(n - a - b + 2)}{2} \\ &= \frac{(n - a - b + 1)(n - a - b + 2)}{2} \\ &= \binom{n - a - b + 2}{2}. \end{aligned}$$

Then  $N_{LR} = 2^{\binom{n-a-b+2}{2}}$ .



Similarly, the number of positions with Left on the left and right for  $n \geq 2a$  and Right on the left and right for  $n \geq 2b$  respectively, then are

$$N_{LL} = \binom{n - 2a + 2}{2} \quad N_{RR} = \binom{n - 2b + 2}{2}.$$

Since these are the only three possibilities for pairs of pieces, Equation (4.2) follows immediately.  $\square$

It is easy to see that if  $a = b = 1$ , then the previous two bounds are

$$f_1 = 2n;$$

$$f_2 = 4 \binom{n}{2}.$$

These are the bounds given in Proposition 4.7.

**Example 4.11.** Consider  $W(2, 3)$  on the path  $P_5$ . In the monomials of legal positions let  $x_{i,j}$  represent a Left piece occupying the spaces  $i$  and  $j$ , and similarly for  $y_{i,j,k}$ . For example, the position in Figure 4.4 is represented by  $x_{1,2}y_{3,4,5}$ .

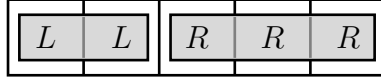

Figure 4.4: An Example Position for  $W(2, 3)$  on  $P_5$

The maximum monomials then are

$$\{x_{1,2}x_{3,4}, x_{1,2}x_{4,5}, x_{1,2}y_{3,4,5}, x_{2,3}x_{4,5}, y_{1,2,3}x_{4,5}, y_{2,3,4}\}.$$

The corresponding simplicial complex is given in Figure 4.5.

By Propositions 4.9 and 4.10 we have

$$f_0 = 1$$

$$f_1 = 2n - a - b + 2 = 7,$$

$$f_2 = \binom{n - 2a + 2}{2} + 2 \binom{n - a - b + 2}{2} = 5,$$

and since  $\max\{\lfloor n/a \rfloor, \lfloor n/b \rfloor\} = 2$ , we get the  $f$ -vector  $(1, 7, 5)$ , which can be verified from the simplicial complex.

To compare this with the Kruskal-Katona bound, we first need to find the  $i$ -canonical representations and calculate the  $j$ th pseudopowers.

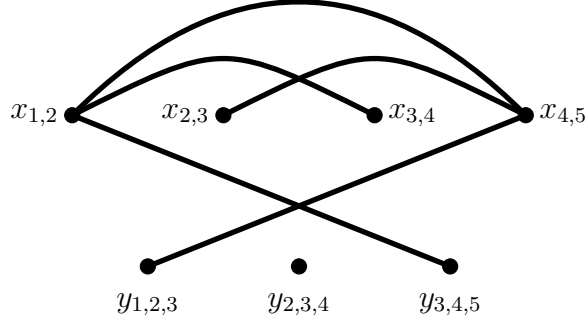
Figure 4.5: The Game Complex  $\Delta_{W(2,3), P_5}$ 

$$\begin{aligned}
 f_1 &= \binom{7}{1} & f_1^{(2)} &= \binom{7}{2} = 21 \\
 f_2 &= \binom{3}{2} + \binom{2}{1} & f_2^{(3)} &= \binom{3}{3} + \binom{2}{2} = 2 \\
 & & f_2^{(1)} &= \binom{3}{1} + \binom{2}{0} = 4
 \end{aligned}$$

Then  $f_2 = 5 < f_1^{(2)} = 21$ ,  $f_3 = 0 < f_2^{(3)} = 2$ , and  $f_1 = 7 > f_2^{(1)} = 4$ , showing that the formulae in Propositions 4.9 and 4.10 give, at least for this example, improved necessary conditions for a vector to be the  $f$ -vector of a game complex over the ones given in the Kruskal-Katona theorem.

We will now show that for fixed  $a$  and  $b$  and sufficiently large  $n$ , then the bound in Proposition 4.10 on  $f_2$  is better than the Kruskal-Katona bound. By the Kruskal-Katona theorem we have

$$\begin{aligned}
 f_2 &\leq f_1^{(2)} = \binom{2n - a - b + 2}{2} \\
 &= \frac{1}{2} [4n^2 + n(6 - 4a - 4b) + g(a, b)],
 \end{aligned}$$

where  $g(a, b)$  is a function in  $a$  and  $b$ , whereas Proposition 4.10 gives

$$\begin{aligned}
 f_2 &= \binom{n - 2a + 1}{2} + \binom{n - 2b + 1}{2} + 2 \binom{n - a - b + 1}{2} \\
 &= \frac{1}{2} [4n^2 + 2n(6 - 4a - 4b) + h(a, b)],
 \end{aligned}$$

where  $h(a, b)$  is a function in  $a$  and  $b$ . Since  $a, b \geq 1$ , and thus  $6 - 4a - 4b < 0$ , we have  $\frac{1}{2} [4n^2 + 2n(6 - 4a - 4b) + g(a, b)] < \frac{1}{2} [4n^2 + n(6 - 4a - 4b) + h(a, b)]$ , showing that as  $n$  grows larger our bound becomes increasingly better than the Kruskal-Katona bound.

The results in Propositions 4.9 and 4.10 can also be generalized to include more players. We will show how to take the argument from the 2-player case and apply it to the  $t$ -player game for this board. The proof for the generalization to the  $t$ -player case will be along the same lines for the other classes of boards.

**Corollary 4.12.** *Consider the  $t$ -player weight game  $W(a_1, \dots, a_t)$  played on  $P_n$ . The number of positions with one piece placed by player  $i$  is*

$$N_i = \begin{cases} 0 & \text{if } a_i > n, \\ n - a_i + 1 & \text{if } a_i \leq n. \end{cases} \quad (4.3)$$

If a simplicial complex corresponds to this game then

$$f_1 = \sum_{i=1}^t N_i.$$

*Proof.* As in the proof to Proposition 4.9, we will consider where we are able to place the left-most end of a piece of weight  $a_i$  if  $a_i \leq n$ . As in the 2-player case, there are  $n - a_i + 1$  possibilities, proving Equation (4.3). The number of positions with one piece, i.e. the value for  $f_1$ , is then the sum of these over all players.  $\square$

**Corollary 4.13.** *Consider the  $t$ -player weight game  $W(a_1, \dots, a_t)$  played on  $P_n$ . The number of positions with two pieces placed by player  $i$  is*

$$N_{ii} = \begin{cases} 0 & \text{if } 2a_i > n, \\ \binom{n-2a_i+2}{2} & \text{if } 2a_i \leq n. \end{cases}$$

The number of positions with one piece placed by player  $i$  and one piece by player  $j$  where  $i \neq j$  is

$$N_{ij} = \begin{cases} 0 & \text{if } a_i + a_j > n, \\ 2 \binom{n-a_i-a_j+2}{2} & \text{if } a_i + a_j \leq n. \end{cases}$$

If a simplicial complex corresponds to this game then

$$f_2 = \sum_{i=1}^t \sum_{j=i}^t N_{ij}. \quad (4.4)$$

*Proof.* Proving the formula for  $N_{ii}$  uses the same argument as proving the formula for  $N_{LL}$  in the 2-player case, and  $N_{ij}$  for  $i \neq j$  is the same as  $N_{LR}$  in the two player case. Summing over all pairs of indices  $(i, j)$  where order does not matter gives the number of positions with two pieces played, proving Equation (4.4).  $\square$

*Remark 4.14* (For the game theorist). The game O12 is the weight game  $W(1, 2, \cdot)$ . It is mentioned by Brown et al. in [6] that this game played on a path is equivalent to the partizan Octal game where Left removes one piece and Right two, and both have the possibility to split the heap. It is easy to see that weight games played on a path are all equivalent to a specific partizan Octal game.

#### 4.4 Playing on the Cycle $C_n$

Consider Left playing pieces of weight  $a$  and Right pieces of weight  $b$  on a cycle of length  $n \geq 3$ . For this board, the ‘left’ end of a piece is the end in counter-clockwise direction.

**Proposition 4.15.** *If a simplicial complex corresponds to the game  $W(a, b)$  played on  $C_n$  then*

$$f_1 = \begin{cases} 0 & \text{if } a, b > n, \\ n & \text{if either } a \leq n \text{ or } b \leq n \text{ but not both,} \\ 2n & \text{if } a, b \leq n. \end{cases} \quad (4.5)$$

*Proof.* The left end of a piece can be placed on any of the  $n$  spaces if its weight is less than  $n$ , no matter if it is a Right or Left piece.  $\square$

**Proposition 4.16.** *If a simplicial complex corresponds to the weight game  $W(a, b)$  played on  $C_n$  then*

$$f_2 = N_{LL} + N_{LR} + N_{RR} \quad (4.6)$$

where

$$N_{LL} = \begin{cases} 0 & \text{if } 2a > n, \\ \frac{n(n-2a+1)}{2} & \text{if } 2a \leq n, \end{cases} \quad N_{RR} = \begin{cases} 0 & \text{if } 2b > n, \\ \frac{n(n-2b+1)}{2} & \text{if } 2b \leq n, \end{cases}$$

are the number of positions with two Left pieces, respectively two Right pieces, and

$$N_{LR} = \begin{cases} 0 & \text{if } a + b > n, \\ n(n - a - b + 1) & \text{if } a + b \leq n, \end{cases}$$

is the number of positions with one Left and one Right piece.

*Proof.* We will first look at the number of positions with two Left pieces if  $n \geq 2a$ . There are  $n$  choices for placing the first piece. Placing the second piece is equivalent to placing one piece on the path  $P_{n-a}$ , i.e. there are  $(n-a) - a + 1$  choice for placing the second piece. Due to symmetry, there are then  $n(n-2a+1)/2$  positions of this form. Similarly, the number of positions with two Right pieces is  $n(n-2b+1)/2$  if  $n \geq 2b$ .

To count the number of positions with one Left and one Right piece when  $n \geq a+b$ , we first place the Left, then the Right piece. There are  $n$  choices for placing the Left piece. Placing the Right piece is then equivalent to placing a piece of weight  $b$  on the path  $P_{n-a}$ , i.e. there are  $(n-a) - b + 1$  choices for placing the second pieces. Thus, there are  $n(n-a-b+1)$  positions of this form.  $\square$

It is easy to see that if  $a = b = 1$ , then the previous two bounds are

$$f_1 = 2n;$$

$$f_2 = 4 \binom{n}{2}.$$

These are the bounds given in Proposition 4.7.

**Example 4.17.** Consider  $W(2, 3)$  on the cycle  $C_5$ . Let  $x_{i,j}$  represent a Left piece occupying spaces  $i$  and  $j$ , and similarly for  $y_{i,j,k}$ . E.g. the position in Figure 4.6 is represented by  $x_{1,2}y_{3,4,5}$ .

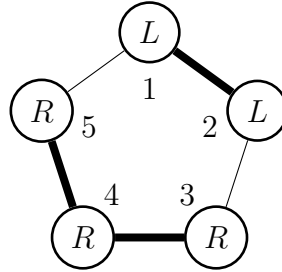

Figure 4.6: An Example Position for  $W(2, 3)$  on  $C_5$

The maximum monomials then are

$$\{x_{1,2}x_{3,4}, x_{1,2}x_{4,5}, x_{1,2}y_{3,4,5}, x_{2,3}x_{4,5}, x_{2,3}x_{1,5}, x_{2,3}y_{1,4,5},$$

$$x_{3,4}x_{1,5}, x_{3,4}y_{1,2,5}, x_{4,5}y_{1,2,3}, x_{1,5}y_{2,3,4}\}$$

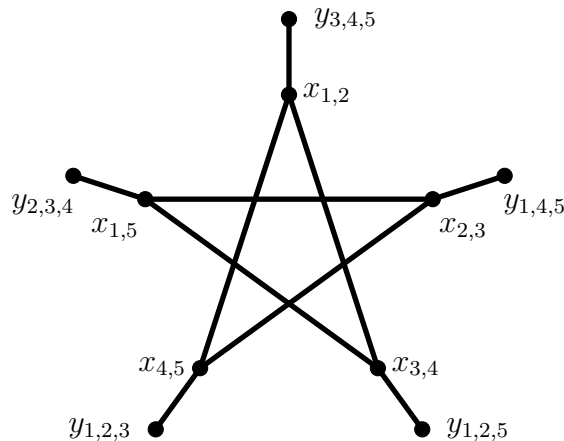

Figure 4.7: The Game Complex  $\Delta_{W(2,3),C_5}$

The corresponding simplicial complex is given in Figure 4.7.

By Propositions 4.15 and 4.16 we have

$$\begin{aligned} f_0 &= 1 \\ f_1 &= 2n = 10, \\ f_2 &= \frac{n(n-2a+1)}{2} + n(n-a-b+1) = 10, \end{aligned}$$

and since  $\max\{\lfloor n/a \rfloor, \lfloor n/b \rfloor\} = 2$ , we get the  $f$ -vector  $(1, 10, 10)$ , which can be verified from the simplicial complex.

To compare this with the Kruskal-Katona bound, we first need to find the  $i$ -canonical representations and calculate the  $j$ th pseudopowers.

$$\begin{aligned} f_1 &= \binom{10}{1} & f_1^{(2)} &= \binom{10}{2} = 45 \\ f_2 &= \binom{5}{2} & f_2^{(3)} &= \binom{5}{3} = 10 \\ & & f_2^{(1)} &= \binom{5}{1} = 5 \end{aligned}$$

Then  $f_2 = 10 < f_1^{(2)} = 45$ ,  $f_3 = 0 < f_2^{(3)} = 10$ , and  $f_1 = 10 > f_2^{(1)} = 5$ , showing that the formulae in Propositions 4.15 and 4.16 give, at least for this example, improved necessary conditions for a vector to be the  $f$ -vector of a game complex over the ones given in the Kruskal-Katona theorem.

We will now show that for fixed  $a$  and  $b$  and sufficiently large  $n$ , then the bound

in Proposition 4.16 on  $f_2$  is better than the Kruskal-Katona bound. By the Kruskal-Katona theorem we have

$$\begin{aligned} f_2 &\leq f_1^{(2)} = \binom{2n}{2} \\ &= \frac{1}{2} [4n^2 + n(-2)], \end{aligned}$$

whereas Proposition 4.16 gives

$$\begin{aligned} f_2 &= \frac{n(n-2a+1)}{2} + \frac{n(n-2b+1)}{2} + n(n-a-b+1) \\ &= \frac{1}{2} [4n^2 + n(4-4a-4b)]. \end{aligned}$$

Since  $a, b \geq 1$ , and thus  $4-4a-4b \leq -4$ , we have  $\frac{1}{2} [4n^2 + n(4-4a-4b)] < \frac{1}{2} [4n^2 + n(-2)]$ , showing that as  $n$  grows larger our bound becomes increasingly better than the Kruskal-Katona bound.

Propositions 4.15 and 4.16 can again be generalized to more players using the same methods of proof.

**Corollary 4.18.** *Consider the  $t$ -player weight game  $W(a_1, \dots, a_t)$  played on  $C_n$ . The number of positions with one piece placed by player  $i$  is*

$$N_i = \begin{cases} 0 & \text{if } a_i > n, \\ n & \text{if } a_i \leq n. \end{cases}$$

If a simplicial complex corresponds to such a game then

$$f_1 = \sum_{i=1}^t N_i.$$

**Corollary 4.19.** *Consider the  $t$ -player weight game  $W(a_1, \dots, a_t)$  played on  $C_n$ . The number of positions with two pieces placed by player  $i$  is*

$$N_{ii} = \begin{cases} 0 & \text{if } 2a_i > n, \\ n(n-2a_i+1)/2 & \text{if } 2a_i \leq n. \end{cases}$$

The number of positions with one piece placed by player  $i$  and one piece by player  $j$  is

$$N_{ij} = \begin{cases} 0 & \text{if } a_i + a_j > n, \\ n(n-a_i-a_j+1) & \text{if } a_i + a_j \leq n. \end{cases}$$

If a simplicial complex corresponds to such a game then

$$f_2 = \sum_{i=1}^t \sum_{j=i}^t N_{ij}.$$

#### 4.5 Playing on the Complete Graph $K_n$

Consider Left playing pieces of weight  $a$  and Right pieces of weight  $b$  on a complete graph of  $n$  vertices.

**Proposition 4.20.** *If a simplicial complex corresponds to the weight game  $W(a, b)$  played on  $K_n$  then*

$$f_k = \sum_{l=0}^k \left( \frac{\prod_{i=0}^{k-l-1} \binom{n-ia}{a}}{(k-l)!} \right) \left( \frac{\prod_{j=0}^{l-1} \binom{n-(k-l)a-jb}{b}}{l!} \right) \quad (4.7)$$

for  $k \geq 0$ .

*Proof.* Playing a piece of weight  $a$  on the complete graph with  $n$  vertices is equivalent to deleting  $a$  vertices from the graph. Thus placing a second piece on the graph is equivalent to placing a piece on the complete graph on  $n - a$  vertices.

Also, since every pair of vertices is connected, playing a piece of weight  $a$  is equivalent to playing  $a$  pieces of weight 1, thus there are  $\binom{n}{a}$  choices for placing the piece.

Thus playing  $s$  pieces of weight  $a$  we have

$$\frac{\prod_{i=0}^{s-1} \binom{n-ia}{a}}{s!}$$

choices. Then playing  $k - l$  pieces of weight  $a$  and  $l$  pieces of weight  $b$  (assuming without loss of generality we place the pieces of weight  $a$  first) we have

$$\frac{\prod_{i=0}^{k-l-1} \binom{n-ia}{a}}{(k-l)!} \frac{\prod_{j=0}^{l-1} \binom{n-(k-l)a-jb}{b}}{l!}$$

different positions.

To get the total number of positions with  $k$  pieces played, we let  $l$  range from 0 to  $k$  and add the terms, giving Equation (4.7).  $\square$



If  $a = b$ , then the previous bound becomes

$$\begin{aligned}
f_k &= \sum_{l=0}^k \frac{n(n-1)\cdots(n-(k-l)a+1)(n-(k-l)a)\cdots(n-ka+1)}{(k-l)!l!(a!)^k} \\
&= \frac{n!}{(n-ka)!(a!)^k} \sum_{l=0}^k \frac{1}{k!} \binom{k}{l} \\
&= \frac{n!}{(n-ka)!k!(a!)^k} \sum_{l=0}^k \binom{k}{l} \\
&= \frac{n!}{(n-ka)!k!(a!)^k} 2^k.
\end{aligned}$$

If  $a = b = 1$ , then this becomes

$$\begin{aligned}
f_k &= \frac{n!}{(n-k)!k!} 2^k \\
&= \binom{n}{k} 2^k
\end{aligned}$$

which is the bound given in Proposition 4.7.

If we assume without loss of generality that  $a \leq b$ , then we have

$$\begin{aligned}
f_k &= \sum_{l=0}^k \frac{n(n-1)\cdots(n-(k-l)a-lb+1)}{(k-l)!l!(a!)^{k-l}(b!)^l} \\
&= \frac{n!}{k!} \sum_{l=0}^k \frac{\binom{k}{l}}{(a!)^{k-l}(b!)^l(n-(k-l)a-lb)!} \\
&\leq \frac{n!}{k!} \sum_{l=0}^k \frac{\binom{k}{l}}{(a!)^k(n-kb)!} \\
&= \frac{n!}{(n-kb)!k!(a!)^k} 2^k.
\end{aligned}$$

We can similarly find a lower bound. Thus

$$\frac{n!}{(n-ka)!k!(b!)^k} 2^k \leq f_k \leq \frac{n!}{(n-kb)!k!(a!)^k} 2^k.$$

For fixed  $a, b$ , and  $k$ , we then have

$$n(n-1)\cdots(n-ka+1) \frac{2^k}{k!(b!)^k} \leq f_k \leq n(n-1)\cdots(n-kb+1) \frac{2^k}{k!(a!)^k},$$

and since  $n(n-1)\cdots(n-ka+1) \geq (n-ka+1)^{ka}$  and  $n(n-1)\cdots(n-kb+1) \leq n^{kb}$ , this implies

$$C'(n-ka+1)^{ka} = C'n^{ka} + O(n^{ka-1}) \leq f_k \leq Cn^{kb},$$

where  $C$  and  $C'$  are constants depending on  $a$  and  $k$ , respectively  $b$  and  $k$ .

Also note that  $W(a, b)$  played on the complete graph  $K_n$  is the least restrictive game on the most connected board. Thus the formula in Proposition 4.20 gives upper bounds for any placement game with weights on any board.

**Example 4.21.** Consider  $W(2, 2)$  and let the board be the complete graph  $K_4$ . Let  $x_{i,j}$  represent a Left piece occupying the vertices  $i$  and  $j$ , and similarly for  $y_{i,j}$ . For example the position in Figure 4.8 is represented by  $x_{1,4}y_{2,3}$ .

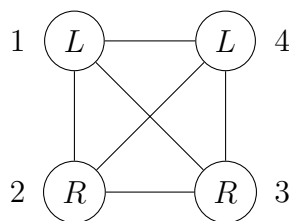

Figure 4.8: An Example Position for  $W(2, 2)$  on  $K_4$

The corresponding simplicial complex is given in Figure 4.9.

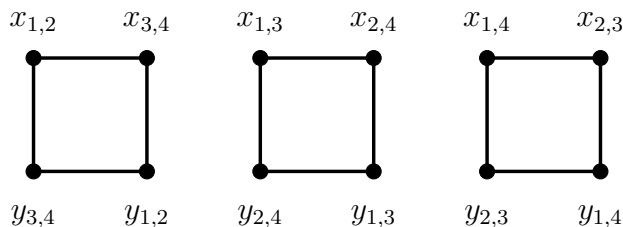

Figure 4.9: The Game Complex  $\Delta_{W(2,2),K_4}$

By Proposition 4.20 we have

$$\begin{aligned}
 f_0 &= 1 \\
 f_1 &= \binom{n}{a} + \binom{n}{b} = 12, \\
 f_2 &= \frac{\binom{n}{a}\binom{n-a}{a}}{2} + \binom{n}{a}\binom{n-a}{b} + \frac{\binom{n}{b}\binom{n-b}{b}}{2} = 12,
 \end{aligned}$$

and since  $\max\{\lfloor n/a \rfloor, \lfloor n/b \rfloor\} = 2$ , we get the  $f$ -vector  $(1, 12, 12)$ , which can be verified from the simplicial complex.

To compare this with the Kruskal-Katona bound, we first need to find the  $i$ -canonical representations and calculate the  $j$ th pseudopowers.

$$\begin{aligned} f_1 &= \binom{12}{1} & f_1^{(2)} &= \binom{12}{2} = 66 \\ f_2 &= \binom{5}{2} + \binom{2}{1} & f_2^{(3)} &= \binom{5}{3} + \binom{2}{2} = 11 \\ & & f_2^{(1)} &= \binom{5}{1} + \binom{2}{0} = 6 \end{aligned}$$

Then  $f_2 = 12 < f_1^{(2)} = 66$ ,  $f_3 = 0 < f_2^{(3)} = 11$ , and  $f_1 = 12 > f_2^{(1)} = 6$ , showing that the formula in Proposition 4.20 gives, at least for this example, improved necessary conditions for a vector to be the  $f$ -vector of a game complex over the ones given in the Kruskal-Katona theorem.

We will now show that for fixed  $a$  and  $b$  and sufficiently large  $n$ , the bound in Proposition 4.20 for  $f_2$  is better than the Kruskal-Katona bound. By the Kruskal-Katona theorem we have

$$\begin{aligned} f_2 &\leq f_1^{(2)} = \binom{\binom{n}{a} + \binom{n}{b}}{2} \\ &= \frac{1}{2} \left[ \binom{n}{a} \left( \binom{n}{a} + 2\binom{n}{b} - 1 \right) + \binom{n}{b} \left( \binom{n}{b} - 1 \right) \right], \end{aligned}$$

whereas Proposition 4.20 gives

$$\begin{aligned} f_2 &= \frac{1}{2} \binom{n}{a} \binom{n-a}{a} + \frac{1}{2} \binom{n}{b} \binom{n-b}{b} + \binom{n}{a} \binom{n-a}{b} \\ &= \frac{1}{2} \left[ \binom{n}{a} \left( \binom{n-a}{a} + 2\binom{n-a}{b} \right) + \binom{n}{b} \binom{n-b}{b} \right]. \end{aligned}$$

Recall that  $f(n) = O(g(n))$  means that  $f(n) \leq Cg(n)$  for some positive constant  $C$ . Then  $f(n) = O(n^k)$  means that  $f(n)$  is bounded by a polynomial of degree at most  $k$ . Also recall that  $f(n) = g(n) + O(n^k)$  means  $f(n) - g(n) = O(n^k)$ .

Since

$$\begin{aligned} \binom{n}{i} &= \frac{1}{i!} \left( n^i - n^{i-1} \frac{i(i-1)}{2} + O(n^{i-2}) \right) \text{ for } i \geq 2 \\ \binom{n-i}{j} &= \frac{1}{j!} \left( n^j - n^{j-1} \frac{j(j+2i-1)}{2} + O(n^{j-2}) \right) \text{ for } j \geq 2 \end{aligned}$$

it easily follows that  $\binom{n-a}{a} + 2\binom{n-a}{b} \leq \binom{n}{a} + 2\binom{n}{b} - 1$  and  $\binom{n-b}{b} \leq \binom{n}{b} - 1$ . Thus

$$\begin{aligned} & \frac{1}{2} \left[ \binom{n}{a} \left( \binom{n-a}{a} + 2\binom{n-a}{b} \right) + \binom{n}{b} \binom{n-b}{b} \right] \\ & < \frac{1}{2} \left[ \binom{n}{a} \left( \binom{n}{a} + 2\binom{n}{b} - 1 \right) + \binom{n}{b} \left( \binom{n}{b} - 1 \right) \right], \end{aligned}$$

showing that the new bound is better than the Kruskal-Katona bound as  $n$  grows larger.

We have not compared the bounds for  $f_k$  with  $k > 2$  since it is difficult to find the  $i$ -canonical representation of  $f_{k-1}$  in this case.

Generalizing the proof of Proposition 4.20 to several players we get

**Corollary 4.22.** *Consider the  $t$ -player weight game  $W(a_1, \dots, a_t)$  played on  $K_n$ . If a simplicial complex corresponds to such a game then*

$$f_k = \sum_{\substack{0 \leq l_1, \dots, l_t \\ l_1 + \dots + l_t = k}} \left( \prod_{j=1}^t \frac{\prod_{i=0}^{l_j-1} \binom{n - ia_j - \sum_{v=1}^{j-1} l_v a_v}{a_j}}{l_j!} \right)$$

for  $k \geq 1$ . □

Similar to the 2-player case, if  $a_1 = \dots = a_t =: a$ , then we can simplify this formula:

$$\begin{aligned} f_k &= \sum_{\substack{0 \leq l_1, \dots, l_t \\ l_1 + \dots + l_t = k}} \frac{n(n-1) \cdots (n - (\sum_{i=0}^t l_j a) + 1)}{\prod_{j=1}^t (l_j!) (a!)^{l_j}} \\ &= \sum_{\substack{0 \leq l_1, \dots, l_t \\ l_1 + \dots + l_t = k}} \frac{n(n-1) \cdots (n - ka + 1)}{(a!)^k \prod_{j=1}^t (l_j!)} \\ &= \frac{n!}{(n - ka)! k! (a!)^k} \sum_{\substack{0 \leq l_1, \dots, l_t \\ l_1 + \dots + l_t = k}} \frac{k!}{\prod_{j=1}^t (l_j!)} \\ &= \frac{n!}{(n - ka)! k! (a!)^k} \sum_{\substack{0 \leq l_1, \dots, l_t \\ l_1 + \dots + l_t = k}} \binom{k}{l_1, \dots, l_t} \\ &= \frac{n!}{(n - ka)! k! (a!)^k} t^k. \end{aligned}$$

where  $\binom{k}{l_1, \dots, l_t}$  is the multinomial coefficient.

If  $a = 1$ , then this becomes

$$\begin{aligned} f_k &= \frac{n!}{(n-k)!k!} t^k \\ &= \binom{n}{k} t^k, \end{aligned}$$

which is the same bound as in Corollary 4.8.

Letting  $a_{max} = \max\{a_1, \dots, a_t\}$  and  $a_{min} = \min\{a_1, \dots, a_t\}$ , we similarly get the bounds

$$\frac{n!}{(n - ka_{min})!k!(a_{max}!)^k} t^k \leq f_k \leq \frac{n!}{(n - ka_{max})!k!(a_{min}!)^k} t^k.$$

For fixed  $a_j$ , we then have

$$f_k \leq C n^{ka_{max}}$$

and

$$f_k \geq C'(n - ka_{min} + 1)^{ka_{min}} = C' n^{ka_{min}} + O(n^{ka_{min}-1})$$

where  $C$  and  $C'$  are constants depending on  $a_{min}$  and  $k$ , respectively  $a_{max}$  and  $k$ .

#### 4.6 Playing on the Complete Bipartite Graph $K_{n,m}$

Finally, for the complete bipartite graph, we will introduce the concept of balanced weights.

**Definition 4.23.** The weight of a piece placed on a complete bipartite graph is called **balanced** if the difference between the number of vertices covered in the two parts is less than or equal to 1.

The TRIVIAL placement game in which Left plays pieces of balanced weight  $a$  and Right of balanced weight  $b$  is denoted by  $W'(a, b)$ . Similarly for the  $t$ -player game.

Now, consider Left playing pieces of balanced weight  $a$  and Right playing pieces of balanced weight  $b$  on the complete bipartite graph  $K_{n,m}$ .

**Proposition 4.24.** *In the game  $W'(a, b)$  played on the complete bipartite graph  $K_{n,m}$ , the number of positions with one Left piece or one Right piece, are, respectively*

$$N_L = \begin{cases} \binom{n}{a/2} \binom{m}{a/2} & \text{if } a \text{ is even,} \\ \sum_{k=1}^2 \binom{n}{\frac{a+(-1)^k}{2}} \binom{m}{\frac{a-(-1)^k}{2}} & \text{if } a \text{ is odd,} \end{cases}$$

$$N_R = \begin{cases} \binom{n}{b/2} \binom{m}{b/2} & \text{if } b \text{ is even,} \\ \sum_{k=1}^2 \binom{n}{\frac{b+(-1)^k}{2}} \binom{m}{\frac{b-(-1)^k}{2}} & \text{if } b \text{ is odd.} \end{cases}$$

If a simplicial complex corresponds to such a game, then

$$f_1 = N_L + N_R.$$

*Proof.* To place a piece of balanced weight  $a$  on the complete bipartite graph  $K_{n,m}$ , we have to alternate occupying vertices between the two parts  $V_1$  and  $V_2$ . Since every vertex in  $V_1$  is connected to every vertex in  $V_2$ , and  $|V_1| = n$  and  $|V_2| = m$ , we have  $\binom{n}{s} \binom{m}{t}$  choices to place a piece that would occupy  $s$  vertices in the first part and  $t$  vertices in the second part.

If  $a$  is even, then having to alternate between the parts means that exactly  $a/2$  vertices are occupied in the first part and in the second part. If  $a$  is odd, then we can either place on  $\frac{a-1}{2}$  vertices in the first part and  $\frac{a+1}{2}$  vertices in the second part, or vice versa. Thus we get the formula for  $N_L$  and  $N_R$  is found similarly.  $\square$

**Proposition 4.25.** *In the game  $W'(a, b)$  played on the complete bipartite graph  $K_{n,m}$ , the number of positions with two Left piece is*

$$N_{LL} = \begin{cases} (1/2) \prod_{k=0}^1 \binom{n - a/2k}{a/2} \binom{m - a/2k}{a/2} & \text{if } a \text{ is even,} \\ (1/2) \sum_{k=1}^2 \left[ \binom{n}{\frac{a+(-1)^k}{2}} \binom{m}{\frac{a-(-1)^k}{2}} \cdot \right. \\ \left. \sum_{j=1}^2 \left[ \binom{n - \frac{a+(-1)^k}{2}}{\frac{a+(-1)^j}{2}} \binom{m - \frac{a-(-1)^k}{2}}{\frac{a-(-1)^j}{2}} \right] \right] & \text{if } a \text{ is odd,} \end{cases}$$

the number of positions with two Right piece is

$$N_{RR} = \begin{cases} (1/2) \prod_{k=0}^1 \binom{n - b/2k}{b/2} \binom{m - b/2k}{b/2} & \text{if } b \text{ is even,} \\ (1/2) \sum_{k=1}^2 \left[ \binom{n}{\frac{b+(-1)^k}{2}} \binom{m}{\frac{b-(-1)^k}{2}} \cdot \right. \\ \left. \sum_{j=1}^2 \left[ \binom{n - \frac{b+(-1)^k}{2}}{\frac{b+(-1)^j}{2}} \binom{m - \frac{b-(-1)^k}{2}}{\frac{b-(-1)^j}{2}} \right] \right] & \text{if } b \text{ is odd,} \end{cases}$$

and the number of positions with one Left and one Right piece is

$$N_{LR} = \begin{cases} \binom{n}{a/2} \binom{m}{a/2} \binom{n-a/2}{b/2} \binom{m-a/2}{b/2} & \text{if } a, b \text{ are even,} \\ \binom{n}{b/2} \binom{m}{b/2} \sum_{k=1}^2 \left[ \binom{n-b/2}{\frac{a+(-1)^k}{2}} \binom{m-b/2}{\frac{a-(-1)^k}{2}} \right] & \text{if } a \text{ is odd, } b \text{ is even,} \\ \binom{n}{a/2} \binom{m}{a/2} \sum_{k=1}^2 \left[ \binom{n-a/2}{\frac{b+(-1)^k}{2}} \binom{m-a/2}{\frac{b-(-1)^k}{2}} \right] & \text{if } a \text{ is even, } b \text{ is odd,} \\ \sum_{k=1}^2 \left[ \binom{n}{\frac{a+(-1)^k}{2}} \binom{m}{\frac{a-(-1)^k}{2}} \cdot \right. \\ \quad \left. \sum_{j=1}^2 \left[ \binom{n-\frac{a+(-1)^k}{2}}{\frac{b+(-1)^j}{2}} \binom{m-\frac{a-(-1)^k}{2}}{\frac{b-(-1)^j}{2}} \right] \right] & \text{if } a, b \text{ are odd.} \end{cases}$$

If a simplicial complex corresponds to such a game, then

$$f_2 = N_{LL} + N_{LR} + N_{RR}.$$

*Proof.* Placing a piece that covers  $s$  vertices in the first part and  $t$  vertices in the second part is equivalent to deleting those vertices, resulting in a complete bipartite graph  $K_{n-s, m-t}$ . Thus playing the second piece is equivalent to placing one piece on  $K_{n-s, m-t}$ . Using Proposition 4.24, we then get the formulas for  $N_{LL}, N_{RR}$ , and  $N_{LR}$ , considering symmetry in the case of two Left or two Right pieces. As an example, we will demonstrate how to find  $N_{LR}$  if both  $a$  and  $b$  are odd.

We will first place the Left piece. From Proposition 4.24 we know that there are  $\sum_{k=1}^2 \binom{n}{\frac{a+(-1)^k}{2}} \binom{m}{\frac{a-(-1)^k}{2}}$  choices for this. If the Left piece occupies  $(a+1)/2$  vertices in the first part and  $(a-1)/2$  vertices in the second part, then playing the Right piece is equivalent to playing on  $K_{n-\frac{a+1}{2}, m-\frac{a-1}{2}}$ . So for this case we have

$$\binom{n}{\frac{a+1}{2}} \binom{m}{\frac{a-1}{2}} \sum_{j=1}^2 \left[ \binom{n-\frac{a+1}{2}}{\frac{b+(-1)^j}{2}} \binom{m-\frac{a-1}{2}}{\frac{b-(-1)^j}{2}} \right]$$

possibilities to place the two pieces. Similarly, if the Left piece occupies  $(a-1)/2$  vertices in the first part and  $(a+1)/2$  vertices in the second part, then we have

$$\binom{n}{\frac{a-1}{2}} \binom{m}{\frac{a+1}{2}} \sum_{j=1}^2 \left[ \binom{n-\frac{a-1}{2}}{\frac{b+(-1)^j}{2}} \binom{m-\frac{a+1}{2}}{\frac{b-(-1)^j}{2}} \right]$$

possible ways to place the pieces. Adding the two gives  $N_{LR}$  in the case that  $a$  and  $b$  are odd.  $\square$

If  $a = b = 1$ , then the previous two bounds become

$$f_1 = 2(n + m) = \binom{n + m}{1} 2^1$$

and

$$f_2 = 2(n + m)(n + m - 1) = \binom{n + m}{2} 2^2$$

which are the bounds given in Proposition 4.7.

**Example 4.26.** Consider the game  $W'(3, 2)$  and let the board be the complete bipartite graph  $K_{2,2}$ . Let  $x_{i,j,k}$  represent a Left piece occupying the vertices  $i, j$ , and  $k$ , and similarly for  $y_{i,j}$ . For example, the position in Figure 4.10 is represented by  $x_{1,3,4}$ .

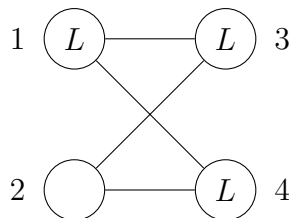

Figure 4.10: An Example Position for  $W'(3, 2)$  on  $K_{2,2}$

The corresponding game complex is given in Figure 4.11.

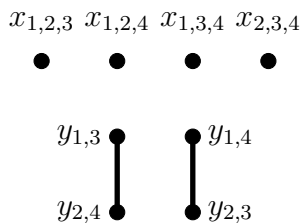

Figure 4.11: The Game Complex  $\Delta_{W(3,2),K_{2,2}}$

Since this game has no additional rules, the bounds in Propositions 4.24 and 4.25 hold with equality. Thus

$$f_0 = 1$$

$$f_1 = \binom{2}{1} + \binom{2}{1} + \binom{2}{1} \binom{2}{1} = 8,$$

$$f_2 = \frac{\binom{2}{1} \binom{2}{1}}{2} = 2,$$



and since  $\max\{\lfloor (n+m)/a \rfloor, \lfloor (n+m)/b \rfloor\} = 2$ , we get the  $f$ -vector  $(1, 8, 2)$ , which can be verified from the simplicial complex.

To compare this with the Kruskal-Katona bound, we first need to find the  $i$ -canonical representations and calculate the  $j$ th pseudopowers.

$$\begin{aligned} f_1 &= \binom{8}{1} & f_1^{(2)} &= \binom{8}{2} = 28 \\ f_2 &= \binom{2}{2} + \binom{1}{1} & f_2^{(3)} &= \binom{2}{3} + \binom{1}{2} = 0 \\ & & f_2^{(1)} &= \binom{2}{1} + \binom{1}{0} = 3 \end{aligned}$$

Then  $f_2 = 2 < f_1^{(2)} = 28$ ,  $f_3 = 0 = f_2^{(3)}$ , and  $f_1 = 8 > f_2^{(1)} = 3$ , showing that the formulae in Propositions 4.24 and 4.25 give, at least for this example, improved necessary conditions for a vector to be the  $f$ -vector of a game complex over the ones given in the Kruskal-Katona theorem.

We can continue the argument from the last two cases to find formulas for any  $f_k$  when playing on a complete bipartite graph with balanced weights. The formulas become complicated though since many cases need to be covered (all combinations of  $a$  and  $b$  even or odd), thus we have chosen not to include them.

These results can again be generalized to more players using the same methods of proof.

**Corollary 4.27.** *Consider a  $t$ -player placement game played on  $K_{n,m}$  where player  $i$  plays pieces of balanced weight  $a_i$ . The number of positions with one piece placed by player  $i$  is*

$$N_i = \begin{cases} \binom{n}{a_i/2} \binom{m}{a_i/2} & \text{if } a_i \text{ is even,} \\ \sum_{k=1}^{\lfloor a_i/2 \rfloor} \binom{n}{a_i+(-1)^k} \binom{m}{a_i-(-1)^k} & \text{if } a_i \text{ is odd} \end{cases}$$

If a simplicial complex corresponds to such a game then

$$f_1 = \sum_{i=1}^t N_i. \tag{4.8}$$

**Corollary 4.28.** *Consider a  $t$ -player placement game played on  $K_{n,m}$  where player  $i$  plays pieces of balanced weight  $a_i$ . The number of positions with two pieces placed by*

player  $i$  is

$$N_{ii} = \begin{cases} (1/2) \prod_{k=0}^1 \binom{n - a_i/2k}{a_i/2} \binom{m - a_i/2k}{a/2} & \text{if } a_i \text{ is even,} \\ (1/2) \sum_{k=1}^2 \left[ \binom{n}{\frac{a_i+(-1)^k}{2}} \binom{m}{\frac{a_i-(-1)^k}{2}} \cdot \right. \\ \left. \sum_{j=1}^2 \left[ \binom{n - \frac{a_i+(-1)^k}{2}}{\frac{a_i+(-1)^j}{2}} \binom{m - \frac{a_i-(-1)^k}{2}}{\frac{a_i-(-1)^j}{2}} \right] \right] & \text{if } a_i \text{ is odd,} \end{cases}$$

The number of positions with one piece placed by player  $i$  and one piece by player  $j$  where  $i \neq j$  is

$$N_{ij} = \begin{cases} \binom{n}{a_i/2} \binom{m}{a_j/2} \binom{n - a_i/2}{a_j/2} \binom{m - a_i/2}{a_j/2} & \text{if } a_i, a_j \text{ are even,} \\ \binom{n}{a_j/2} \binom{m}{a_j/2} \sum_{k=1}^2 \left[ \binom{n - a_j/2}{\frac{a_i+(-1)^k}{2}} \binom{m - a_j/2}{\frac{a_i-(-1)^k}{2}} \right] & \text{if } a_i \text{ is odd, } a_j \text{ is even,} \\ \binom{n}{a_i/2} \binom{m}{a_i/2} \sum_{k=1}^2 \left[ \binom{n - a_i/2}{\frac{a_j+(-1)^k}{2}} \binom{m - a_i/2}{\frac{a_j-(-1)^k}{2}} \right] & \text{if } a_i \text{ is even, } a_j \text{ is odd,} \\ \sum_{k=1}^2 \left[ \binom{n}{\frac{a_i+(-1)^k}{2}} \binom{m}{\frac{a_i-(-1)^k}{2}} \cdot \right. \\ \left. \sum_{j=1}^2 \left[ \binom{n - \frac{a_i+(-1)^k}{2}}{\frac{a_j+(-1)^j}{2}} \binom{m - \frac{a_i-(-1)^k}{2}}{\frac{a_j-(-1)^j}{2}} \right] \right] & \text{if } a_i, a_j \text{ are odd.} \end{cases}$$

If a simplicial complex corresponds to such a game then

$$f_2 = \sum_{i=1}^t \sum_{j=i}^t N_{ij}. \quad (4.9)$$

## Chapter 5

### Conclusion: Open Questions and Discussion

There are many more questions on placement games and their monomials, their ideals, and their simplicial complexes. In this chapter, we will be discussing some of them.

#### 5.1 Commutative Algebra of Placement Games

In Section 2.3, we introduced the legal and illegal ideals of a placement game, which are the facet and Stanley-Reisner ideals of its game complex. One of the main roots of combinatorial commutative algebra lies in the relation between square-free monomial ideals and simplicial complexes. In a similar manner, we would like to explore the connection between placement games and square-free monomial ideals. Especially, we are interested in how the algebra of these ideals affects the game itself.

For example, we are interested in how the following are mirrored in a placement game  $G$ :

- deletion-contraction operations (localization),
- Betti numbers of the legal ideal and the  $h$ -vector of the game complex,
- Alexander dual of the ideals and simplicial complexes,
- the game complex being Cohen-Macaulay,
- the game complex being acyclic, and
- resolutions of the legal ideal.

#### 5.2 Doppelgänger and Isomorphic Game Complexes

As we have shown in Section 3.3, distance games in which the illegal distances between two Left pieces and two Right pieces are the same do not have a Doppelgänger on the

set of all boards. A natural question is whether there exists a game  $G$  with  $L_G \neq R_G$  that has a Doppelgänger on all boards. Or even more generally, does a board exist for all pairs of placement games on which they are not Doppelgänger?

This question is also related to two game complexes being isomorphic. We know that two games for which this is the case are Doppelgänger, and we can directly conclude that their ideals are also isomorphic from their complexes being isomorphic, but we would like to know how else they are related.

On the other hand, are there any Doppelgänger whose complexes are not isomorphic? We know that non-isomorphic simplicial complexes exist that have the same  $f$ -vector, but we do not know if they would both be game complexes, and if they are, whether they would correspond to the same board.

### 5.3 On Distance Games and Games with Weight

The two classes of placement games introduced, distance games and games with weight, also allow for further research.

For distance games, we would also like to find Kruskal-Katona type bounds on the coefficients of the game polynomials. A natural question is also if we can generalize the concepts of the 2-player game to  $t$ -player distance games. For example would a  $t$ -player version of the bipartite flip still have the same nice properties as the 2-player version discussed in Section 3.2?

For games with weights, it would be very exciting if we could find Kruskal-Katona type bounds for any board such that they hold with equality if there are no additional rules. This seems very difficult though.

Further, it is still open whether Proposition 4.5 can be generalized to all boards, i.e. is any game with weight equivalent to a game with all weights 1. This is certainly true for all examples in this thesis, but the construction of the equivalent game is often non-trivial.

An interesting question would also be if we can combine the two, i.e. can we define distance games with weights? Ideally, the distance between pieces with weight greater than 1 should be defined in such a way that we can use results from the distance games with weight 1. It seems very likely that, for example, to define a bipartite flip, we would need the weights of the players to be the same.

## 5.4 Overall

The main goal still is to find sufficient conditions for a simplicial complex to be a game complex. Since it is already not easy to find necessary conditions for a vector to be the  $f$ -vector of a game complex, this seems to be very hard and much further work is needed.

## Bibliography

- [1] M.H. Albert, R.J. Nowakowski, and D. Wolfe. *Lessons in Play*. A K Peters, Ltd., Wellesley, MA, 2007.
- [2] E.R. Berlekamp, J.H. Conway, and R.K. Guy. *Winning ways for your mathematical plays. Vol. 1*. Academic Press Inc. [Harcourt Brace Jovanovich Publishers], London, 1982.
- [3] E.R. Berlekamp, J.H. Conway, and R.K. Guy. *Winning ways for your mathematical plays. Vol. 1*. A K Peters Ltd., Wellesley, MA, second edition, 2004.
- [4] J. A. Bondy and U. S. R. Murty. *Graph theory*, volume 244 of *Graduate Texts in Mathematics*. Springer, New York, 2008.
- [5] C.L. Bouton. Nim, a game with complete mathematical theory. *Ann. Math.*, 3:35–39, 1902.
- [6] J.I. Brown, D. Cox, A. Hoefel, N. McKay, R. Milley, R.J. Nowakowski, and A.A. Siegel. Polynomial profiles of placement games. Preprint 2013.
- [7] J. H. Conway. *On numbers and games*. Academic Press [Harcourt Brace Jovanovich Publishers], London, 1976. London Mathematical Society Monographs, No. 6.
- [8] S. Faridi. The facet ideal of a simplicial complex. *Manuscripta Math.*, 109(2):159–174, 2002.
- [9] G. Farr and J. Schmidt. On the number of Go positions on lattice graphs. *Inform. Process. Lett.*, 105(4):124–130, 2008.
- [10] G. E. Farr. The Go polynomials of a graph. *Theoret. Comput. Sci.*, 306(1-3):1–18, 2003.
- [11] M. Gardner. Mathematical games: Cram, crosscram and quadruphage: new games having elusive winning strategies. *Scientific American*, 230(2):106–108, 1974.
- [12] P.M. Grundy. Mathematics and games. *Eureka*, 2:6–8, 1939. A later version is published in *Eureka* 27 (1964) 9–11.
- [13] M. Hochster. Cohen-Macaulay rings, combinatorics, and simplicial complexes. In *Ring theory, II (Proc. Second Conf., Univ. Oklahoma, Norman, Okla., 1975)*, pages 171–223. Lecture Notes in Pure and Appl. Math., Vol. 26. Dekker, New York, 1977.

- [14] G. Katona. A theorem of finite sets. In *Theory of graphs (Proc. Colloq., Tihany, 1966)*, pages 187–207. Academic Press, New York, 1968.
- [15] J.B. Kruskal. The number of simplices in a complex. In *Mathematical optimization techniques*, pages 251–278. Univ. of California Press, Berkeley, Calif., 1963.
- [16] G.A. Reisner. Cohen-Macaulay quotients of polynomial rings. *Advances in Math.*, 21(1):30–49, 1976.
- [17] R.P. Sprague. Über mathematische Kampfspiele. *Tôhoku Mathematics Journal*, 13(290):438–444, 1935.
- [18] R.P. Stanley. The upper bound conjecture and Cohen-Macaulay rings. *Studies in Appl. Math.*, 54(2):135–142, 1975.
- [19] J. Tromp and G. Farneback. Combinatorics of go. In *Proceedings of the 5th International Conference on Computers and Games, CG'06*, pages 84–99, Berlin, Heidelberg, 2007. Springer-Verlag.
- [20] R.H. Villarreal. Cohen-Macaulay graphs. *Manuscripta Math.*, 66(3):277–293, 1990.